

Palm

Design by Lievore Altherr Molina, 2004

Art. 1202 1213

Stackable chair with chromed or powdercoated four-leg frame. Polyethylene shell also available upholstered in leather, faux leather, fabric or customer's material. When combined with a powdercoated frame, non upholstered shell is suitable for outdoor use.



Dimensions *

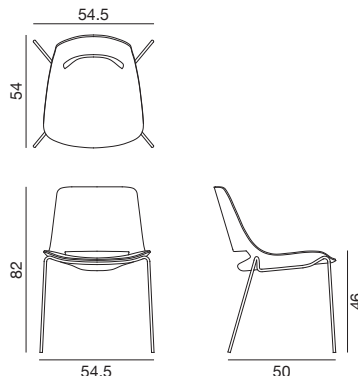

* File CAD 2D - 3D available for download at www.arper.com

Frame Base



Shell

Polyethylene



PE
Polyethylene

Carded In



Graded In

kvadrat

camira



DESIGN
TEX



Gabriel



svensson

maharam

Serge Ferrari

Palm

Design by Lievore Altherr Molina, 2004

SHIPMENT DETAILS

Art.1202

1 pz = 2  - kg 10,4/ m³ 0,25

4 pz = 2  - kg 30,22/ m³ 0,31

1 pz = 2  - kg 10,4/ m³ 0,25

4 pz = 2  - kg 30,22/ m³ 0,31

RESISTANCE TEST

- EN 1728:2000 - EN 15373:2007 6.2.1
- EN 1728:2000 - EN 15373:2007 6.7
- EN 1022:05

- EN 1728:2000 - EN 15373:2007 6.2.2
- EN 1728:2000 - EN 15373:2007 6.8

FIRE RETARDANT TEST

BS5852/06 Clause 12 cigarette match Perla 2.2 • BS5852 i.s. 5 Cava 3 Soft leather Elmosoft Hallingdal 65 Pro 3 Tonus 4 • Classe 1IM Cava 3 Divina MD Divina Melange 2 Divina 3 Hallingdal 65 Pro 3 Soft leather Tonus 4 Faux leather Valencia • California TB117-2013 Cava 3 Clara Canvas Divina MD Divina Melange 2 Divina 3 Soft leather Elmosoft Field Hallingdal 65 Jet Jumper 3 Pro 3 Soft leather Pause 4 Remix 2 Savanna Steelcut 2 Scuba Steelcut Trio 2 Steelcut Trio 3 Sunniva Sunniva 2 Tonus 4 Tempo Faux leather Valencia • BS5852 Sch. 4 Part 1 Cava 3 Divina MD Divina Melange 2 Divina 3 Soft leather Elmosoft Hallingdal 65 Pro 3 Soft leather Tonus 4 Faux leather Valencia • BS5852 Sch. 5 Part 1 Cava 3 Clara Canvas Divina MD Divina Melange 2 Divina 3 Soft leather Elmosoft Hallingdal 65 Soft leather Remix 2 Savanna Steelcut 2 Steelcut Trio 2 Steelcut Trio 3 Tonus 4 Faux leather Valencia • EN 1021 - 1 Divina MD Divina Melange 2 Divina 3 Soft leather Elmosoft Field Hallingdal 65 Pro 3 • EN 1021 - 2 Divina MD Divina Melange 2 Divina 3 Soft leather Elmosoft Field Hallingdal 65 Pro 3

ENVIRONMENTAL CERTIFICATIONS



arper

F +39 0422 791800

T +39 0422 7918

www.arper.com

Stackability:

- Up to 8 pcs. (should the weight exceed 25 kilos a handling tool must be used).
- With trolley: up to 14 pcs.

Palm

Design by Lievore Altherr Molina, 2004

Art. 1205 1214

Stackable chair with chromed or powdercoated four leg frame, fitted with armrests. Polyethylene shell also available upholstered in leather, faux leather, fabric or customer's material. When combined with a powdercoated frame, non upholstered shell is suitable for outdoor use.



Dimensions *

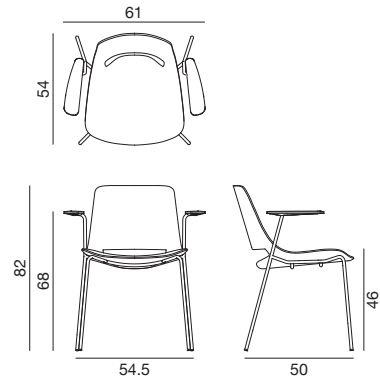

* File CAD 2D - 3D available for download at www.arper.com

Frame Base



Shell

Polyethylene



PE
Polyethylene

Carded In



Graded In

kvadrat

camira



DESIGN
TEX



Gabriel



svensson

maharam

Serge Ferrari

arper

F +39 0422 791800

T +39 0422 7918

www.arper.com

Palm

Design by Lievore Altherr Molina, 2004

SHIPMENT DETAILS

Art.1205

1 pz = 2  - kg 11,16/ m³ 0,32

4 pz = 2  - kg 32/ m³ 0,38

1 pz = 2  - kg 11,16/ m³ 0,32

4 pz = 2  - kg 32/ m³ 0,38

RESISTANCE TEST

- EN 1728:2000 - EN 15373:2007 6.2.1
- EN 1728:2000 - EN 15373:2007 6.7

- EN 1728:2000 - EN 15373:2007 6.2.2
- EN 1022:05

FIRE RETARDANT TEST

BS5852/06 Clause 12 cigarette match Perla 2.2 • BS5852 i.s. 5 Cava 3 Soft leather Elmosoft Hallingdal 65 Pro 3 Tonus 4 • Classe 1IM Cava 3 Divina MD Divina Melange 2 Divina 3 Hallingdal 65 Pro 3 Soft leather Tonus 4 Faux leather Valencia • California TB117-2013 Cava 3 Clara Canvas Divina MD Divina Melange 2 Divina 3 Soft leather Elmosoft Field Hallingdal 65 Jet Jumper 3 Pro 3 Soft leather Pause 4 Remix 2 Savanna Steelcut 2 Scuba Steelcut Trio 2 Steelcut Trio 3 Sunniva Sunniva 2 Tonus 4 Tempo Faux leather Valencia • BS5852 Sch. 4 Part 1 Cava 3 Divina MD Divina Melange 2 Divina 3 Soft leather Elmosoft Hallingdal 65 Pro 3 Soft leather Tonus 4 Faux leather Valencia • BS5852 Sch. 5 Part 1 Cava 3 Clara Canvas Divina MD Divina Melange 2 Divina 3 Soft leather Elmosoft Hallingdal 65 Soft leather Remix 2 Savanna Steelcut 2 Steelcut Trio 2 Steelcut Trio 3 Tonus 4 Faux leather Valencia • EN 1021 - 1 Divina MD Divina Melange 2 Divina 3 Soft leather Elmosoft Field Hallingdal 65 Pro 3 • EN 1021 - 2 Divina MD Divina Melange 2 Divina 3 Soft leather Elmosoft Field Hallingdal 65 Pro 3

ENVIRONMENTAL CERTIFICATIONS



arper

F +39 0422 791800

T +39 0422 7918

www.arper.com

Stackability:

– Up to 8 pcs. (should the weight exceed 25 kilos a handling tool must be used).