

Product Information Guide 2016



CONTENTS

Terms and conditions	pg. 4
Quality certification	pg. 5
Magis's materials and their maintenance	pg. 5
Contract	pg. 6
Alphabetical index	pg. 7
Category index	pg. 7
Instructions for simplified reading of the pricelist	pg. 8

Product
Information
Guide



QUALITY CERTIFICATION



In October 2004, Magis was granted the Quality Certification of the Swiss certification bureau SQS (an IQNet partner) for its management system.

The certification by an accredited external bureau allows Magis to implement a quality management system that meets the international standards of UNI EN ISO 9001:2000.

In December 2007, Magis was granted the ISO 14001:2004 Environmental Certification of the Swiss certification bureau SQS for its environmental management system.

MAGIS'S MATERIALS AND THEIR MAINTENANCE

METALS

Magis uses the following metals in the manufacturing of its products: steel and aluminum tubing, steel plate, steel and stainless steel rod, aluminum sheeting, extruded aluminum profiles and die-cast aluminum.

Surface treatments used:

On steel: chromium plating, cold galvanising, hot galvanising, epoxy coating, cathodolysis coating with polyester.

On aluminum sheeting, aluminum tubing and extruded aluminum profiles: natural and black anodising. On die-cast aluminum: polishing, epoxy coating, titanisation coating with polyester.

Only products bearing the inscription "Suitable for Outdoor Use" should be used outside.

Products not specifically marked with the words "Suitable for Outdoor Use" must not be used outside because they would be subject to permanent damage by the elements.

We advise you to consult with our company before using outdoor products in extreme weather conditions.

CLEANING OF METALS

We recommend using a soft rag, either dry or wet.

When needed, use ph-balanced soap diluted in water.

Do not use abrasive sponges as they may leave scratches.

Immediately dry after washing with a soft rag or chamois leather. Never leave water or other liquids to sit on metal parts.

Avoid contact with all acidic substances.

Periodic maintenance and cleaning allows the products to keep their original look and lengthens the duration of their performance.

For the Al Bombo stool (in die-cast aluminum) we recommend using the special Al Bombo Cleaning Kit.

As die-cast aluminum is not treated with any chemical products or any kind of painting, small marks or irregularities, which might be visible on the surface, should not be considered as faults, but on the contrary as technical results of the nature of aluminum itself.

Aluminum is very likely to dull while using.

Regular care is therefore necessary to maintain its original appearance. We recommend using specific cleaning products for aluminum.

Regular care is therefore necessary to maintain its original appearance. We recommend using specific cleaning products for aluminum.

PLASTICS

The plastic materials used by Magis are numerous. Their choice depends on the desired visual effect and particular durability requirements. In addition, certain additives can be used to guarantee that the plastics pass the most stringent safety tests.

All Magis's plastics are organic and fully recyclable. Their life cycles are long, which is an advantage for the environment.

At the end of their life-cycle, we recommend taking the products or parts of the products to specialised recycling centres.

All products and product parts are coloured throughout and not painted, with the exception of the metallic silver version of the Bombo Family (stool, chair, side tables).

The plastics most used in Magis' production are polypropylene (PP) and ABS.

CLEANING OF PLASTICS

We recommend using a soft rag, either dry or wet.

When needed, use ph-balanced soap diluted in water.

Do not use abrasive sponges as they may leave scratches.

Avoid using acidic products, solvents and products containing ammonia.

Plastic products marked with the label "Suitable for Outdoor Use" can be used outside. However, prolonged exposure to sunlight may cause the fading of colours. This is due to the fact that there are currently no additives available on the market that protect plastics from colour fading.

Periodic maintenance and cleaning allows the products to keep their original look and lengthens the duration of their performance.

WOOD

Because wood is a natural material, there are small differences between the products. These are not to be considered faults, but a characteristic of a natural material.

CLEANING OF WOOD

We recommend using a soft rag, either dry or wet.

If desired, use ph-balanced liquid soap especially formulated for wood, diluted in water.

Do not use abrasive sponges, as they may leave scratches.

Avoid using acidic products, solvents and products containing ammonia.

Avoid exposure to sunlight as this may permanently discolour the surface.

Periodic maintenance and cleaning allows the products to keep their original look and lengthens the duration of their performance.

FSC CERTIFICATION



The mark of responsible forestry

Magis obtained the FSC Certification for the following products:

CARtools
Happy Bird
Reiet

Other products are currently being certified.

Magis sales department remains at your complete disposal for any further information.

CONTRACT

Magis has in recent years significantly expanded its custom-made production to respond to the increasing, and increasingly diverse, requests of the contract market. Today, Magis is in a position to satisfy the following requirements:

Colours of plastics

- we can customise the colours of our injection-moulded products for quantities of no fewer than 300 pieces per colour.
- we can customise the colours of our rotational-moulded products. The quantities must be of at least 30 pieces per colour for large pieces (e.g. Voids, Spun or Raviolo) or at least 50 pieces of smaller products.

Painting

- we can customise the colours of metals and woods for quantities of no fewer than 30 pieces per colour.

Fabric or leather upholstery

- if the client chooses a fabric/leather from our assortment, the minimum quantity requested is 4 pieces.
- if the fabric/leather is supplied by our client – and is therefore not in our assortment – the minimum quantity must be of at least 4 pieces.
please note: the number of metres of fabric/leather to be sent to Magis to upholster the product is indicated on the price list.
- if the fabric/leather is not in our assortment and Magis is required to supply said material, then the minimum quantity must be of at least 20 pieces.

Tables

- Magis is happy to consider making tables of sizes and with finishes that differ from our standard products.

Please do not hesitate to contact Magis sales department for any further information or cost estimates you may be interested in.

ALPHABETICAL INDEX

.....	pag.	
Alma.....	☀ pag.	9
Birds.....	9
Bunky.....	11
News CARtools.....	12
Clouds.....	10
Dodo.....	☀ pag.	13
Downtown.....	13
El Baúl.....	13
Eur.....	14/15
Flying Carpet.....	☀ pag.	16
Football Tape.....	16
News Happy Bird.....	17
Julian.....	☀ pag.	17
Ladrillos.....	18/19
Le Chien Savant.....	☀ pag.	19
Linus.....	20
Little Flare.....	21
Mico.....	☀ pag.	22
Moments of ingenuity.....	23
My First Office.....	23
My House.....	24
My Personal Table(t).....	22
My Space.....	24
My zoo.....	25/26
Nido.....	☀ pag.	27
Paradise Tree.....	27
Piedras Divanetto.....	☀ pag.	28
Piedras Poltroncina.....	☀ pag.	28
Piedras Tavolino.....	☀ pag.	28
Pingy.....	28
Puppy.....	☀ pag.	29/30
Puzzle Carpet.....	30
Reiet.....	30
Rocky.....	31
Seggiolina Pop.....	31
Summer To Spring.....	32/33
Sunny Day.....	16
Trioli.....	☀ pag.	34
News Trotter.....	34
Tuttifrutti.....	34
Villa Julia.....	35

CATEGORY INDEX

Accessories

Birds.....	9
News CARtools.....	12
Clouds.....	10
El Baúl.....	13
Flying Carpet.....	☀ pag.	16
Football Tape.....	16
News Happy Bird.....	17
Le Chien Savant.....	☀ pag.	19
Moments of ingenuity.....	23
My House.....	24
My Space.....	24
My zoo.....	25/26
Nido.....	☀ pag.	27
Pingy.....	28
Puppy.....	☀ pag.	29/30
Puzzle Carpet.....	30
Summer To Spring.....	32/33
Sunny Day.....	16
News Trotter.....	34
Tuttifrutti.....	34
Villa Julia.....	35

Coat hangers

Paradise Tree.....	27
--------------------	-------	----

Bed

Bunky.....	11
------------	-------	----

Shelving systems

Downtown.....	pag.	13
Eur.....	pag.	14/15
Ladrillos.....	pag.	18/19
My First Office.....	pag.	23

Seating

Alma.....	☀ pag.	9	
Dodo.....	☀ pag.	13	
Julian.....	☀ pag.	17	
Mico.....	☀ pag.	22	
Piedras Divanetto.....	☀ pag.	28	
Piedras Poltroncina.....	☀ pag.	28	
Reiet.....	pag.	30
Rocky.....	pag.	31
Seggiolina Pop.....	pag.	31
Trioli.....	☀ pag.	34	

Tables

Linus.....	pag.	20
Little Flare.....	pag.	21
My Personal Table(t).....	pag.	22
Piedras Tavolino.....	☀ pag.	28	

INSTRUCTIONS FOR SIMPLIFIED READING OF THE PRICE LIST

Each product is listed with the description of its materials, article reference, colours and finishes.

The finishes for steel, aluminium, plywood and HPL laminate, as well as the plastic colours, are followed by a number.

The same number in the 2015 catalogue represents finishes and colours and is intended to act as a guide as to the actual finish and colour.

For the chairs and some of the tables, actual colour samples are also available.

The colour number is followed by one of the following abbreviations:

C = which stands for matt or glossy colours

TL = which stands for translucent colours

TR = which stands for transparent colours

To order correctly, please specify the article reference plus the code of the colour/finish.

Example:

MT50 Puppy S orange 1001 C

LEGEND OF PICTOGRAMS:

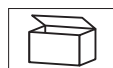

= number of units package

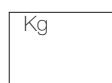

= gross weight carton

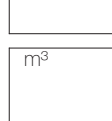

= net weight item

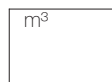

= volume carton



= customs code goods



= shows that the chair/stool/small table is stackable and specifies the maximum number of stacked units



= shows that the product is suitable for outdoor use



= shows that the product needs to be assembled



= important notes

This information is generally also featured in the written product descriptions.

All prices (unless otherwise specified) apply to each individual unit.

Unless otherwise specified, product dimensions are shown in centimetres.

* = only available whilst in stock

Alma

design javier mariscal

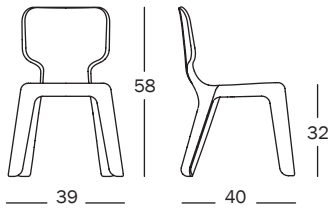

Stacking children's chair.
In polypropylene with glass fibre added.
! Suitable for outdoor use.

MT160

Matt colours:
yellow 1037 C
green 1342 C
brown 1478 C
white 1690 C

4	Kg	8,60	m ³	0,144 (0,44x0,4x0,82)	20	☀️☔️
		1,70		9401.80.00		

Test:

Back impact test, ENV 1729-2
Back static load test, ENV 1729-2
Leg sideways static load test, ENV 1729-2
Seat static load test, ENV 1729-2
Vertical impact test, ENV 1729-2

Back stability, ENV 1729-2
Front stability, ENV 1729-2
Seat impact test, ENV 1792-2
Sideways stability, ENV 1729-2

Birds

design benedetta mori ubaldini

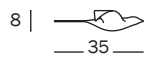

Bird.
Small.

MT340

Matt colour: grey 5069

1	Kg	1,10	m ³	0,052 (0,55x0,55x0,17)
		0,07		7326.20.00

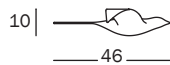
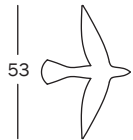

Bird.
Large.

MT342

Matt colour: grey 5069

1	Kg	1,20	m ³	0,052 (0,55x0,55x0,17)
		0,12		7326.20.00

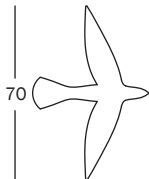

Clouds

design benedetta mori ubaldini

Sculpture in metal mesh painted in epoxy resin. Supplied with hook for ceiling suspension.

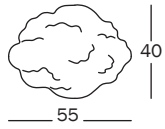

Cloud.
Small.

MT330 Matt colour: white 5110

1	Kg	1,22	m ³	0,106 (0,58x0,48x0,38)
		0,22		7326.20.00

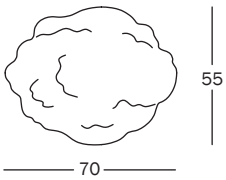
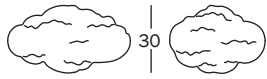

Cloud.
Medium.

MT332 Matt colour: white 5110

1	Kg	1,35	m ³	0,286 (0,9x0,73x0,44)
		0,35		7326.20.00

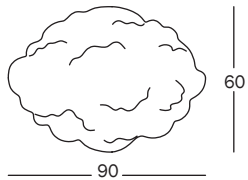

Cloud.
Large.

MT334 Matt colour: white 5110

1	Kg	1,50	m ³	0,286 (0,9x0,73x0,44)
		0,50		7326.20.00



Bunky

design marc newson

Bed/bunk bed.

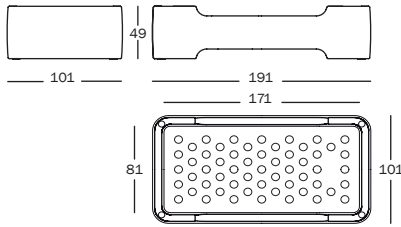

Single bed unit. In polyethylene.

MT800

Matt colours:

light blue 1218 C

dark blue 1232 C

light orange 1652 C

dark orange 1656 C

1	Kg	49,40	m ³	1,014 (1,93x1,03x0,51)	9403.70.00	
		45,00				

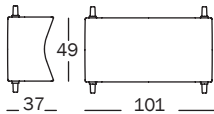

Pair of intermediate units and ladder. In polyethylene.

MT802

Matt colour (ladder):

white 1736 C

Matt colours:

blue 1226 C

orange 1654 C

1	Kg	26,90	m ³	0,515 (1,44x0,65x0,55)	9403.90.90	
		21,00				

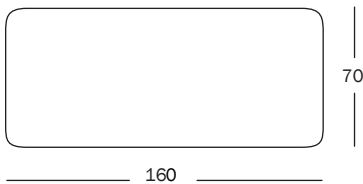
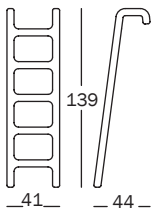

Mattress.

In expanded polyurethane, with removable cover washable at 60° C. Height 10 cm.

MT810

1	Kg	5,80	m ³	0,08 (0,31x0,31x0,83)	9404.29.90
		4,30			

Fitted mattress cover.

In white cotton.

Pillow.

Stuffed in anallergic polyester and covered in white cotton. With removable cover washable at 45°C.

Sheets.

In white cotton.

Pillow cover.

In white cotton with inside pocket.

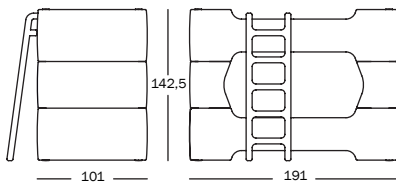
MT812**MT814****MT816****MT818**

Mixed packing (1)	1	Kg	5,00	m ³	0,024 (0,38x0,35x0,18)	9404.90.90
			4,40			

CARtools

design floris hovers

CarTools,
a jigsaw-object in solid beech, comprised
of elements of various shapes, colours
and dimensions, which can be put
together to create different vehicles each
time,
with essential shapes that leave plenty of
room for imagination and individuality.

MT31

	Kg	0,12	m ³	0,004 (0,53x0,15x0,05)
		0,10		3926.40.00

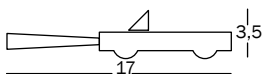
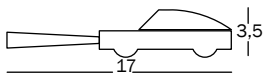
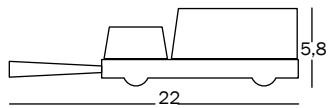
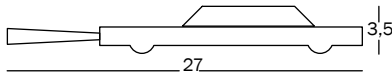
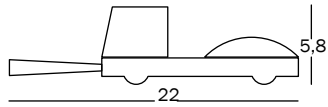
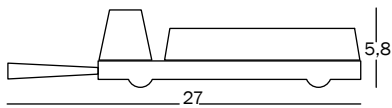
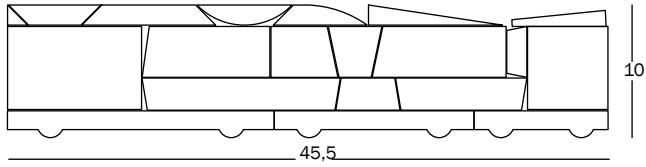

The mark of
responsible forestry

Dodo

design oiva toikka

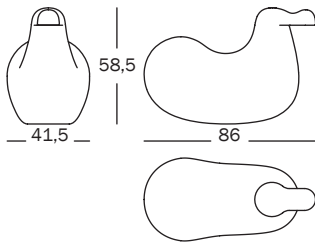

Rocking bird.
In polyethylene.
! Suitable for outdoor use.

MT180 Matt colours:
red 1004 C
yellow 1025 C
blue 1252 C
white 1735 C

1	Kg	7,80	m ³	0,223 (0,88x0,43x0,59)	☀️☔
		5,30		3926.40.00	

Test:

Content of phthalates EN 14372:2004
Flammability, EN 71-2:2006

Determination of cadmium content EN 1122:2001
Migration of elements EN 71-3:1994

Downtown

design oiva toikka

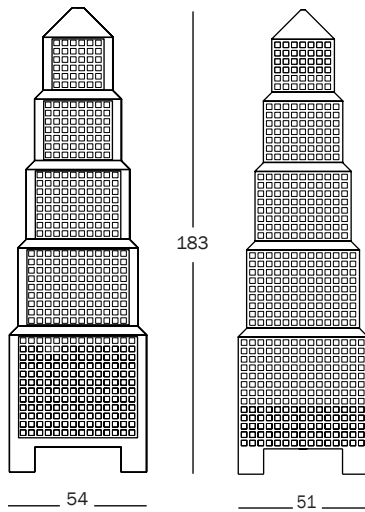

Shelving system.
In polyethylene.

MT250 Matt colour:
white 1736 C

1	Kg	35,50	m ³	0,542 (0,55x0,53x1,86)	9403.70.00
		31,50			

El Baúl

design javier mariscal

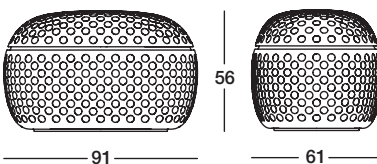

Trunk/container.
In polyethylene.

MT40 Matt colour:
white 1700 C

1	Kg	16,50	m ³	0,317 (0,93x0,62x0,55)	4202.12.19
		13,50			

Test:

Chemical properties, EN 71-3:1994
Mechanical and physical properties, EN 71-1:1998

Flammability, EN 71-2:2003

Eur

design giulio iacchetti

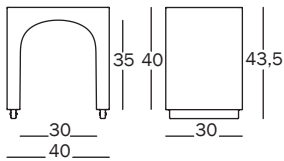
Shelving system, stacking and adjoining.
In expanded polypropylene.

Module A.

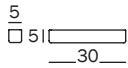
MT550Matt colours:
terracotta 1092 C
blue 1606 C

Foot (for MT550 only).

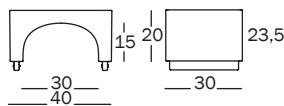
MT551Matt colours:
terracotta 1092 C
blue 1606 C

Module B.

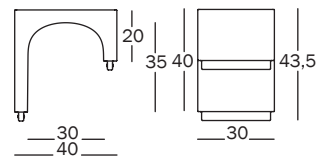

MT552Matt colours:
terracotta 1092 C
blue 1606 C

Module C.

MT554Matt colours:
terracotta 1092 C
blue 1606 C

Pair of hooks for wall fixing.
! Also, we recommend to fix to the wall
 any type of composition.

MT555

Mixed packing (1)		Kg	8,90	m ³	0,229 (0,88x0,42x0,62)	9403.70.00 
			6,40			

WARNING: The basic module for any composition has always to be MT550, according to the law for the children's safety providing that the minimum height is 40 centimetres.

Test:

Drop test, ISO 7170: 2005 L3
 Resistance and durability, ISO 7170: 2005 L3
 Retention test of the shelf, ISO 7170: 2005 L3

Flexion of the shelves, ISO 7170: 2005 L3
 Resistance of shelf supports, ISO 7170: 2005 L3

A

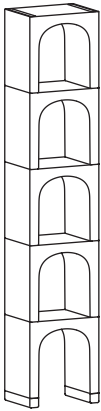

B

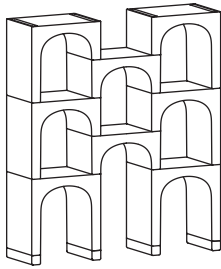

C

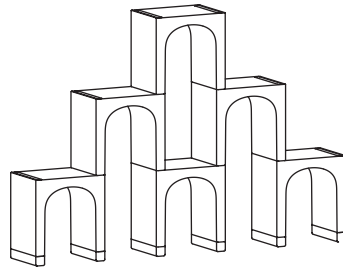

D

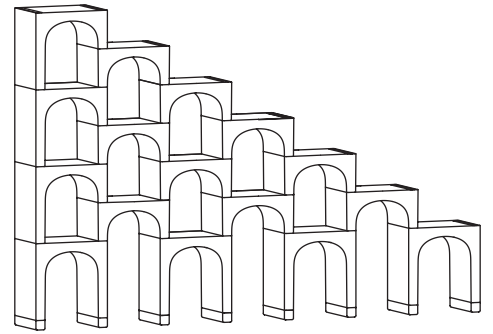

E

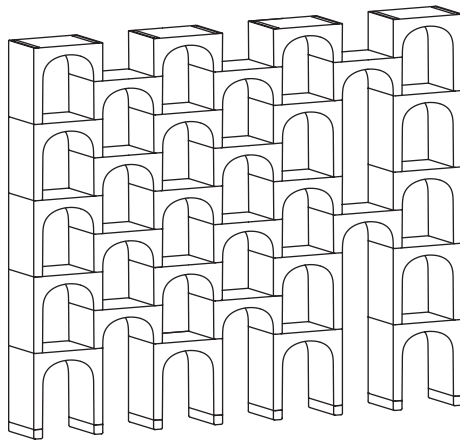

F

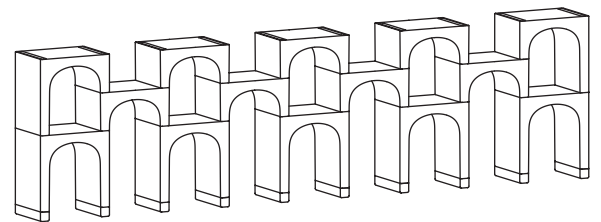

Composition A:

n. 2 feet MT551
 n. 5 modules A MT550
 n. 1 pair of hooks MT555

Composition B:

n. 4 feet MT551
 n. 2 modules A MT550
 n. 2 modules B MT552
 n. 4 modules C MT554
 n. 1 pair of hooks MT555

Composition C:

n. 6 feet MT551
 n. 6 modules A MT550
 n. 1 pair of hooks MT555

Composition D:

n. 8 feet MT551
 n. 4 modules A MT550
 n. 9 modules B MT552
 n. 3 modules C MT554
 n. 1 pair of hooks MT555

Composition E:

n. 8 feet MT551
 n. 6 modules A MT550
 n. 16 modules B MT552
 n. 8 modules C MT554
 n. 1 pair of hooks MT555

Composition F:

n. 10 feet MT551
 n. 5 modules A MT550
 n. 7 modules B MT552
 n. 2 modules C MT554
 n. 1 pair of hooks MT555

Flying Carpet

design eero aarnio

Flying carpet.

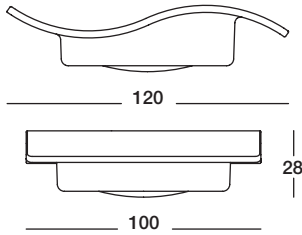

Rocking base in polyethylene.
 ! Suitable for outdoor use.

MT130

Matt colour:
 white 1700 C

1	Kg	25,00	m ³	0,348 (1,21x0,29x1,01)	9403.70.00
		23,00			

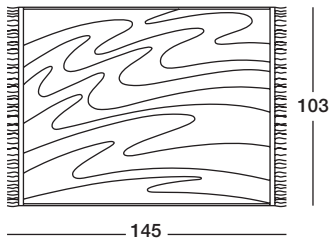

Carpet in coloured polyamide.
 Also available as optional for MT130.

MT132

1	Kg	2,40	m ³	0,008 (0,4x0,4x0,05)	5705.00.30
		1,60			

Test:

Flammability, EN 71-2:2003
 Standard consumer safety specification for toy safety ASTM
 F963-03

Mechanical and physical properties, EN71-1:1998

Sunny Day

design rea aarnio-gibson

Carpet in coloured polyamide.

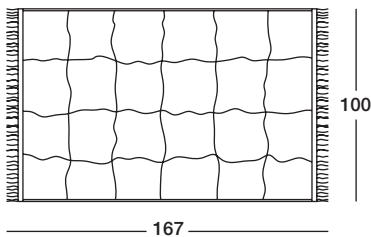
MT134

1	Kg	2,40	m ³	0,008 (0,4x0,4x0,05)	5705.00.30
		1,60			

Football Tape

design martí guixé

Adhesive tape to make paper balls.
 In acrylic polypropylene. Non-toxic.

MT30

6	Kg	1,40	m ³	0,006 (0,12x0,13x0,35)	9503.00.95
		0,20			

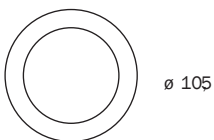
**Test:**

Chemical properties, EN 71-3:1994
 Mechanical and physical properties, EN 71-1:1998

Flammability, EN 71-2:2003

Happy Bird

design eero aarnio

Test:

Flammability, EN71-2:2011

Mechanical and physical properties, EN71-1:2011

Happy Bird

design eero aarnio

Test:

Flammability, EN71-2:2011

Mechanical and physical properties, EN71-1:2011

Julian

design javier mariscal

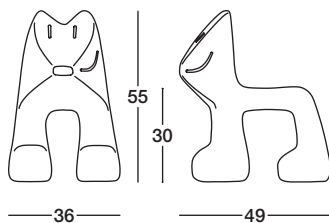

Children's chair.
In polyethylene.
! Suitable for outdoor use.

MT20

Matt colours:

red 1122 C
green 1290 C
yellow 1665 C
white 1735 C

2	Kg	8,20	m ³	0,168 (0,68x0,65x0,38)	9401.80.00	
		3,00				

Test:

Back fatigue test, ENV 1729-2
Back stability, ENV 1729-2
Chemical properties conformity test EN 71-3:1994
Leg forward static load test, UNI 10977:2000
Safety requirements, ENV 1729-2
Seat impact test, ENV 1792-2
Sideways stability, ENV 1729-2

Back impact test, ENV 1729-2
Back static load test, ENV 1729-2
Front stability, ENV 1729-2
Leg sideways static load test, ENV 1729-2
Seat fatigue test, ENV 1729-2
Seat static load test, ENV 1729-2
Vertical impact test, ENV 1729-2

Ladrillos

design javier mariscal

Shelving system.

Shelf supports in polyethylene complete with butterfly screw and fastener in zinc plated steel rod.

Shelves in HPL.

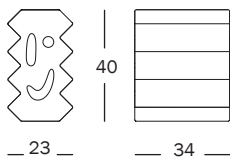

SINO
Base (floor) shelf support.
In polyethylene.

MT81 Matt colour:
dark green 1281 C

	Kg	7,20	m ³	0,079 (0,49x0,37x0,44)	
		3,30		9403.90.90	

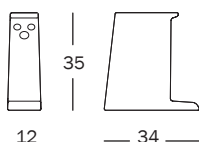

NOK
Stacking shelf support.
In polyethylene.

MT82 Matt colour:
green 1360 C

	Kg	3,50	m ³	0,04 (0,37x0,27x0,4)	
		1,30		9403.90.90	

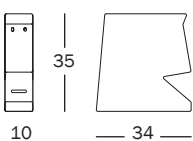

NOLU
Stacking shelf support.
In polyethylene.

MT83 Matt colour:
pink 1623 C

	Kg	3,50	m ³	0,04 (0,37x0,27x0,4)	
		1,30		9403.90.90	

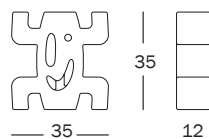

NOMI
Stacking shelf support.
In polyethylene.

MT84 Matt colour:
orange 1085 C

	Kg	4,10	m ³	0,04 (0,37x0,27x0,4)	
		1,50		9403.90.90	

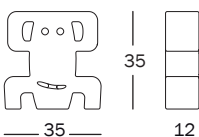

NOMO
Stacking shelf support.
In polyethylene.

MT85 Matt colour:
yellow 1025 C

	Kg	4,10	m ³	0,04 (0,37x0,27x0,4)	
		1,30		9403.90.90	

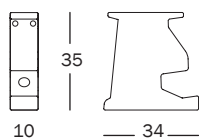

NONO
Stacking shelf support.
In polyethylene.

MT86 Matt colour:
light blue 1220 C

	Kg	3,50	m ³	0,04 (0,37x0,27x0,4)	
		1,30		9403.90.90	

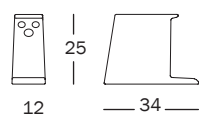

NIK
Stacking shelf support.
In polyethylene.

MT87 Matt colour:
fuchsia 1006 C

	Kg	3,30	m ³	0,041 (0,37x0,38x0,3)	
		1,30		9403.90.90	

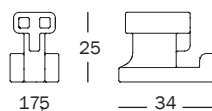

NOSI
Stacking shelf support.
In polyethylene.

MT88 Matt colour:
blue 1252 C

	Kg	4,00	m ³	0,041 (0,37x0,38x0,3)	
		1,30		9403.90.90	

Ladrillos

design javier mariscal

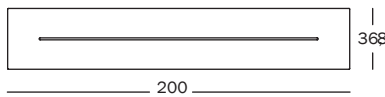

Top.
In HPL white 8500 with black edge.
Thickness 12 mm.

MT90

	kg	40,50	m ³	0,06 (2,05x0,42x0,07)	
		12,40		9403.90.30	

Top.
In HPL white 8500 with black edge.
Thickness 12 mm.

MT92

	kg	26,30	m ³	0,06 (2,05x0,42x0,07)	
		12,40		9403.90.30	

Wall hook.
In zinc plated steel.
! To be used for compositions of 4 shelves or more.

MT94

	kg	0,80			
		0,40		9403.90.30	

Should you wish to provide your own shelves, we suggest you contact us beforehand.

Test:

Safety requirements and test methods, domestic and kitchen storage units and worktops, EN 14749:2005

Le Chien Savant

design philippe starck

according to an idea of c. bavaud

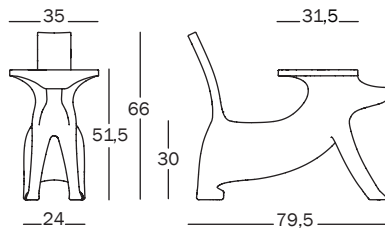

Children's chair/desk.
In polyethylene.
! Suitable for outdoor use.

MT830

Matt colours:
green 1315 C
yellow 1569 C
pink 1628 C
orange 1647 C
white 1735 C

	kg	7,00	m ³	0,201 (0,81x0,37x0,69)	
		5,50		3926.40.00	

Test:

Flammability, EN 71-2:2011
Standard consumer safety specification for toy safety ASTM F963-11

Mechanical and physical properties, EN 71-1:2011

Linus

design javier mariscal

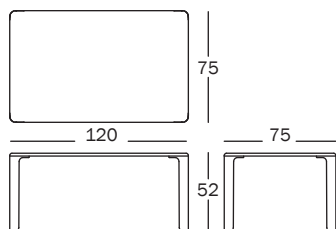



Complete price
table

Leg for children's table.
In polypropylene with glass fibre
added.

MT164 Matt colour:
white 1690 C

Top.
In MDF with polymeric cover white
8500.
Thickness 20 mm.

MT170

	Kg	2,50	m ³	0,016 (0,55x0,17x0,17)	
		0,50		9403.90.90	
	Kg	16,30	m ³	0,05 (1,25x0,8x0,05)	
		10,28		9403.90.30	

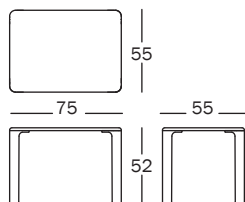
Complete price
table

Leg for children's table.
In polypropylene with glass fibre
added.

MT164 Matt colour:
white 1690 C

Top.
In MDF with polymeric cover white
8500.
Thickness 20 mm.

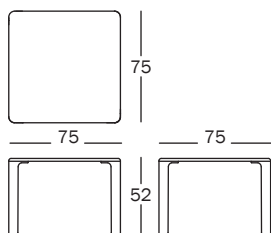
MT166Complete price
table

Leg for children's table.
In polypropylene with glass fibre
added.

MT164 Matt colour:
white 1690 C

Top.
In MDF with polymeric cover white
8500.
Thickness 20 mm.

MT168**Test:**

Drop test resistance, ENV 1729-2
Stability-horizontal impact, ENV 1729-2
Static horizontal load test, ENV 1729-2

Resistance to fatigue horizontal test, ENV 1729-2
Stability-vertical load, ENV 1729-2
Vertical static load test, ENV 1729-2

Little Flare

design marcel wanders

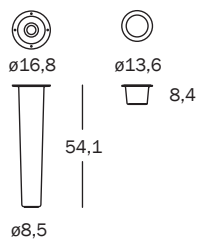

Leg for children's table.
In polycarbonate transparent clear.
Complete with pen holder in ABS orange
1001 C.

MT60

Price for leg

4	Kg	5,80	m ³	0,075 (0,36x0,37x0,56)	9403.90.90	
		4,60				

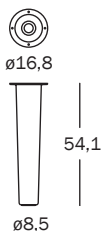

Leg for children's table.
In polycarbonate transparent clear.

MT64

Price for leg

4	Kg	5,40	m ³	0,075 (0,36x0,37x0,56)	9403.90.90	
		4,00				

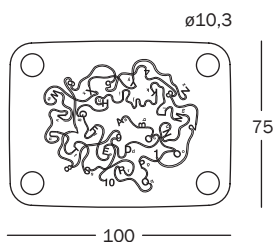

Top.
In MDF with polymeric cover white 8500
with round holes for housing the pen
holders.
Thickness 16 mm.

MT68

Pattern "salad"
Patterns by El Ultimo Grito

1	Kg	10,70	m ³	0,05 (1,05x0,8x0,06)	9403.90.30	
		9,70				

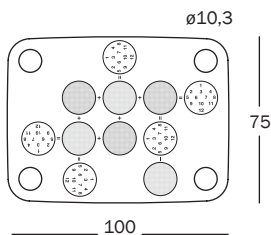
**MT72**

Pattern "circle"
Patterns by El Ultimo Grito

1	Kg	10,70	m ³	0,05 (1,05x0,8x0,06)	9403.90.30	
		9,70				

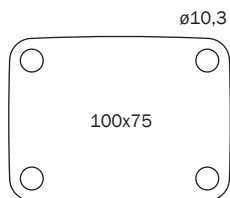
**MT66**

1	Kg	10,70	m ³	0,05 (1,05x0,8x0,06)	9403.90.30	
		10,00				

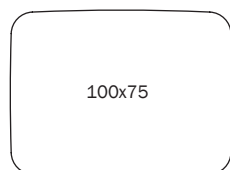

Top.
In MDF with polymeric cover white 8500.
Thickness 16 mm.

MT74

1	Kg	10,70	m ³	0,05 (1,05x0,8x0,06)	9403.90.30	
		10,50				

Test:

Drop test resistance, EN 1730
Resistance to fatigue vertical test, EN 1730
Vertical stability, EN 1730
Worktop resistance impact test, EN 1730

Resistance to fatigue horizontal test, EN 1730
Static horizontal load test, EN 1730
Vertical static load test, EN 1730

! Attention: 8 legs required

MT76



258x75

1	Kg	29,50	m ³	0,128 (2,64x0,81x0,06)	9403.90.30	
		27,00				

My Personal Table(t)

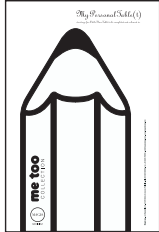

Sketch book with patterns to be completed and coloured.
Set of 20 pages. Patterns by El Ultimo Grito (4). Patterns by Marcel Wanders (6).
White sheets (10).

MT70

1	Kg	2,10	m ³	0,005 (0,6x0,4x0,02)	4903.00.00
		1,50			

Mico

design el ultimo grito

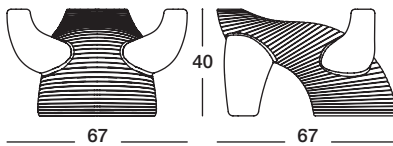

67

40

67

A diverse, multi-purpose object.
In polyethylene.
! Suitable for outdoor use.

MT140

Matt colour:
red 1004 C

1	Kg	7,70	m ³	0,187 (0,68x0,68x0,4)	3926.40.00	
		6,00				

Test:

Mechanical and physical properties, EN 71-1:1998

Standard consumer safety specification for toy safety ASTM F963-03

Moments of ingenuity

signed by oiva toikka

Art serigraphy.

Five colours (The Elephants) or seven colours (The Camel and the Ostrich).

Printed on Fabriano Rosaspina 285gr. paper and mounted on a MDF support.

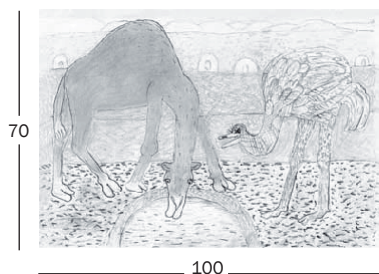

MT300 The Camel and the Ostrich

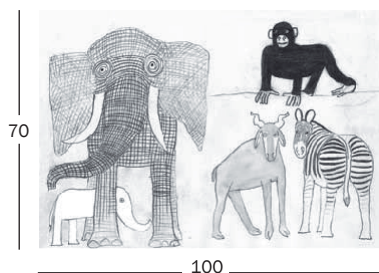

MT302 The Elephants

1	Kg	6,70	m ³	0,035 (1,1x0,79x0,04)
		5,70		9702.00.00

My First Office

design martí guixé

Play/learning space.
In birch plywood. Complete with desk adjustable in height.
Desk top in HPL. Item packaged in wooden crate.

MT370

1	Kg	160,00	m ³	0,471 (1,53x0,4x0,77)
		130,00		9403.60.90

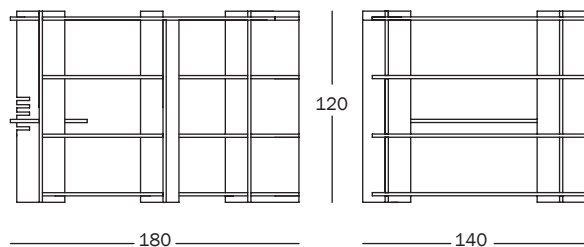

My House

design björn dahlström

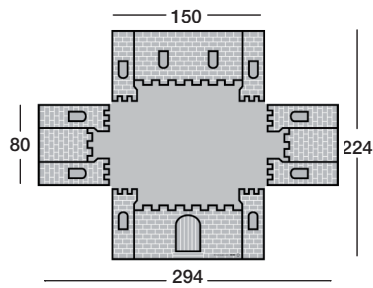

Curtain-cum-table cloth.
In polyester.

MT44

Test:

Standard consumer safety specification for toy safety ASTM F963-03

1	Kg	1,30	m ³	0,009 (0,44x0,41x0,05)	3926.90.97
		1,00			

My Space

design björn dahlström

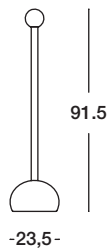

Space divider.
The system is made up of 3 elements: a base in polyethylene, a frame in PVC and a polyester fabric.

Frame and base.

MT32

3	Kg	3,60	m ³	0,043 (0,9x0,24x0,2)	3926.90.97	
		1,10				

Frame and base.

MT34

2	Kg	2,40	m ³	0,043 (0,9x0,24x0,2)	3926.90.97	
		1,10				

Fabric. Pattern A

MT36A

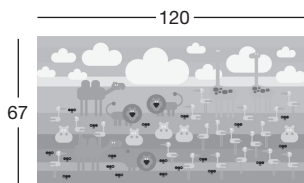

1	Kg	0,20	m ³	0,003 (0,06x0,06x0,85)	3926.90.97	
		0,18				

Fabric. Pattern B

MT36B



1	Kg	0,20	m ³	0,003 (0,06x0,06x0,85)	3926.90.97	
		0,18				

Fabric. Pattern C

MT36C

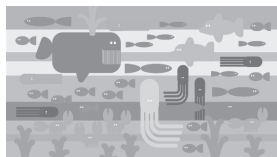

1	Kg	0,20	m ³	0,003 (0,06x0,06x0,85)	3926.90.97	
		0,18				

My zoo

design martí guixé

Animal figures in cardboard.

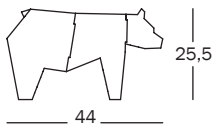
Bear.
Small.**MT650** Matt colour: white

	Kg	0,22	m ³	0,011 (0,7x0,5x0,03)	
		0,12			

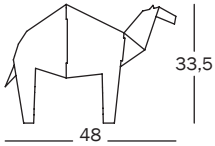
Dromedary.
Small.**MT651** Matt colour: white

	Kg	0,22	m ³	0,011 (0,7x0,5x0,03)	
		0,12			

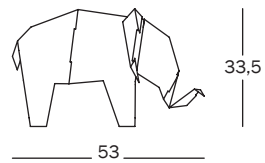
Elephant.
Small.**MT652** Matt colour: white

	Kg	0,21	m ³	0,011 (0,7x0,5x0,03)	
		0,12			

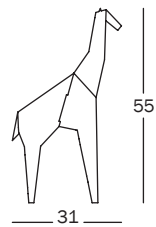
Giraffe.
Small.**MT653** Matt colour: white

	Kg	0,40	m ³	0,011 (0,7x0,5x0,03)	
		0,20			

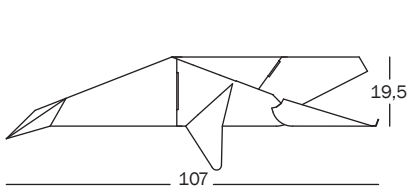
Whale.
Small.**MT654** Matt colour: white

	Kg	0,48	m ³	0,011 (0,7x0,5x0,03)	
		0,28			

My zoo

design martí guixé

Animal figures in cardboard.

Bear.
Large.**MT660** Matt colour: white

1	Kg	2,70	m ³	0,336 (1,6x1,4x0,15)	3926.40.00	
		1,70				

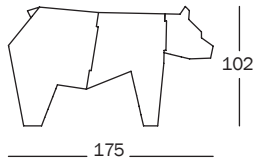
Dromedary.
Large.**MT661** Matt colour: white

1	Kg	2,70	m ³	0,336 (1,6x1,4x0,15)	3926.40.00	
		1,70				

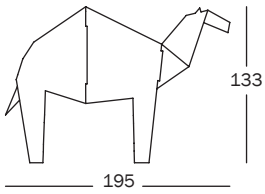
Elephant.
Large.**MT662** Matt colour: white

1	Kg	2,50	m ³	0,336 (1,6x1,4x0,15)	3926.40.00	
		1,50				

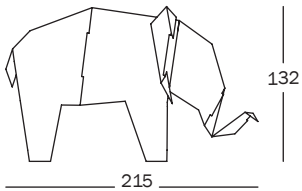
Giraffe.
Large.**MT663** Matt colour: white

1	Kg	3,80	m ³	0,336 (1,6x1,4x0,15)	3926.40.00	
		2,80				

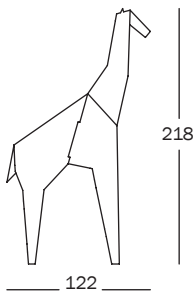
Whale.
Extra large.**MT664** Matt colour: white

1	Kg	22,00	m ³	0,446 (3,12x1,43x0,1)	3926.40.00	
		17,00				

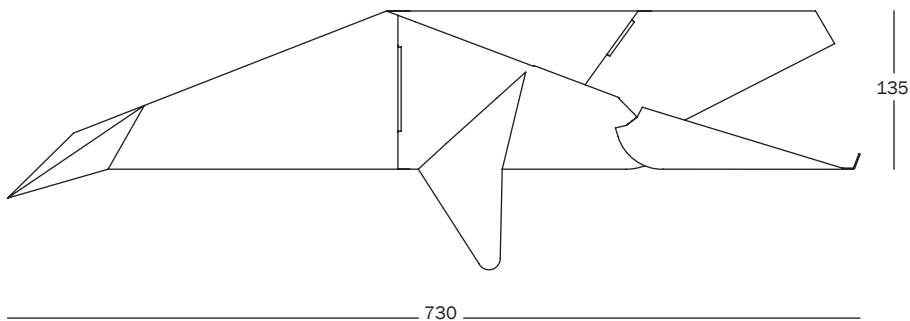

Nido

design javier mariscal

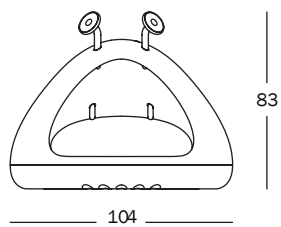

Nest/cave.
In polyethylene. Floor with grass style pattern and graffiti on underside of roof.
! Suitable for outdoor use.

MT25

Matt colours:
yellow (roof) 1025 C
green (base) 1290 C
grey anthracite (antennae) 1420 C

1	kg	41,40	m³	1,168 (1,06x1,53x0,72)	9503.00.95	
		35,00				

Test:

Chemical properties, EN 71-3:1994
Mechanical and physical properties, EN 71-1:1998

Flammability, EN 71-2:2003
Standard consumer safety specification for toy safety ASTM F963-03

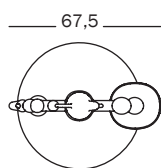
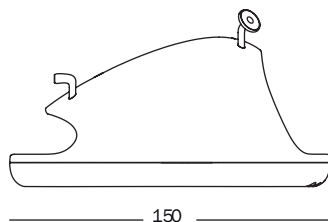

Coat stand.
Elements in polyethylene. Weight and inner frame in galvanized steel.
The base and the two top elements are fixed, the three others are interchangeable.

MT192

Matt colours of the elements from top to base:
red 1004 C
white 1735 C
light blue 1220 C
green 1360 C
yellow 1665 C
orange 1001 C (base)

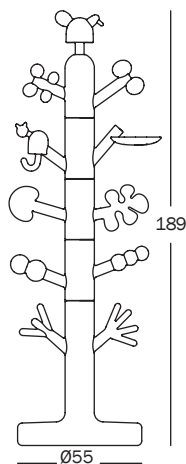

MT190

Matt colour:
white 1735 C

Carton for elements and weight (1)	1	kg	24,40	m³	0,281 (0,66x0,6x0,71)	
			20,70			
Carton for frame (1)	1	kg	1,80	m³	0,002 (1,66x0,03x0,04)	
			1,50			

Piedras Poltroncina

design javier mariscal

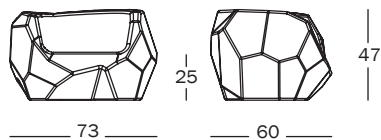

Low chair.
In polyethylene.
! Suitable for outdoor use.

MT150

Matt colour:
grey anthracite 1407 C

1	Kg	8,50	m ³	0,227 (0,62x0,74x0,5)	9403.70.00	
		6,00				

Test:

Chemical properties, EN 71-3:1994
Mechanical and physical properties, EN 71-1:1998

Flammability, EN 71-2:2006

Piedras Divanetto

design javier mariscal

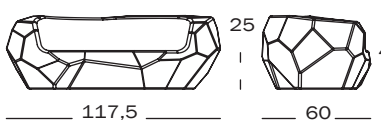

Bench.
In polyethylene.
! Suitable for outdoor use.

MT152

Matt colour:
grey anthracite 1407 C

1	Kg	13,50	m ³	0,37 (0,62x1,2x0,5)	9403.70.00	
		12,00				

Test:

Chemical properties, EN 71-3:1994
Mechanical and physical properties, EN 71-1:1998

Flammability, EN 71-2:2006

Piedras Tavolino

design javier mariscal

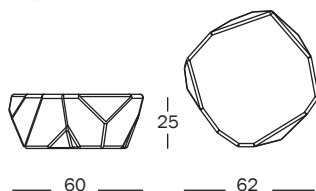

Low table.
In polyethylene.
! Suitable for outdoor use.

MT154

Matt colour:
grey anthracite 1407 C

1	Kg	6,00	m ³	0,104 (0,59x0,61x0,29)	9403.70.00	
		5,00				

Test:

Chemical properties, EN 71-3:1994
Mechanical and physical properties, EN 71-1:1998

Flammability, EN 71-2:2006

Pingy

design eero aarnio

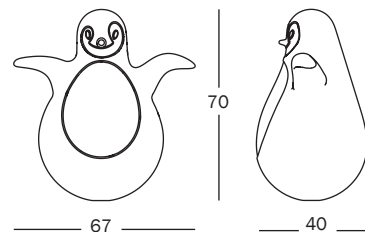

Penguin.
In polyethylene.

MT600

Matt colours:
body black 1763 C
details painted white 1735 C

1	Kg	8,00	m ³	0,173 (0,49x0,49x0,72)	3926.40.00	
		5,90				

Test:

Chemical properties, EN 71-3:1994
Mechanical and physical properties, EN 71-1:2011

Flammability, EN 71-2:2011

Puppy

design eero aarnio

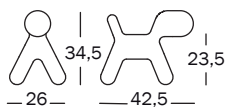

Abstract plastic dog.
In polyethylene.
Small.
! Suitable for outdoor use.

MT50

Matt colours:
orange 1001 C
green 1360 C
white 1700 C

Item packed 1 per carton

	Kg	3,40	m ³	0,077 (0,45x0,46x0,38)	
		0,90		3926.40.00	
	Kg	1,90	m ³	0,045 (0,45x0,37x0,27)	
		0,90		3926.40.00	

MT280

Dalmatian

	Kg	1,90	m ³	0,045 (0,45x0,37x0,27)	
		0,90		3926.40.00	

Puppy

design eero aarnio

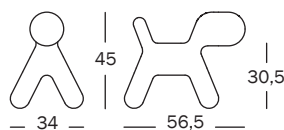

Abstract plastic dog.
In polyethylene.
Medium.
! Suitable for outdoor use.

MT52

Matt colours:
orange 1001 C
green 1360 C
white 1700 C

Item packed 1 per carton

	Kg	5,60	m ³	0,156 (0,58x0,55x0,49)	
		1,70		3926.40.00	
	Kg	3,00	m ³	0,093 (0,58x0,35x0,46)	
		1,70		3926.40.00	

MT282

Dalmatian

	Kg	3,00	m ³	0,093 (0,58x0,35x0,46)	
		1,70		3926.40.00	

Puppy

design eero aarnio

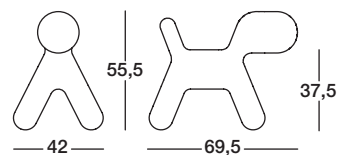

Abstract plastic dog.
In polyethylene.
Large.
! Suitable for outdoor use.

MT54

Matt colours:
orange 1001 C
green 1360 C
white 1700 C

MT284

Dalmatian

	Kg	5,00	m ³	0,168 (0,69x0,42x0,58)	
		4,00		3926.40.00	

Test:

Chemical properties, EN 71-3:1994
Mechanical and physical properties, EN 71-1:1998

Flammability, EN 71-2:2003

Puppy

design eero aarnio

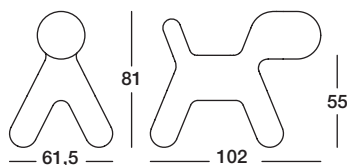

Abstract plastic dog.
In polyethylene.
Extra Large.
! Suitable for outdoor use.

MT56 Matt colours:
orange 1001 C
green 1360 C
white 1700 C

MT286 Dalmatian

	Kg	12,50	m ³	0,58 (1,08x0,65x0,83)	
		11,50		3926.40.00	

Test:

Chemical properties, EN 71-3:1994

Flammability, EN 71-2:2003

Puzzle Carpet

design satyendra pakhalé

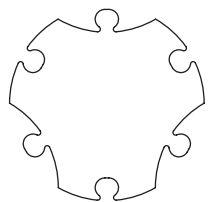

36,0

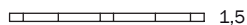

1,5

Puzzle carpet.
In soft expanded polyethylene coupled
with polyester fabric.
! N.B.: please specify pattern with your
order.

MT18 Patterns:
water
sand
grass

	Kg	1,20	m ³	0,022 (0,38x0,35x0,15)	9503.00.69
		0,10			

Test:

Flammability, EN 71-2:2003

Reiet

design javier mariscal

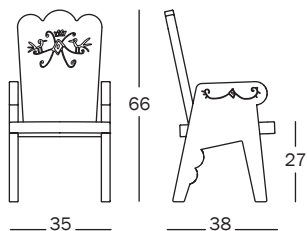

35

38

Children's chair.
In painted solid beech.

MT400 Matt colours:
yellow 7003
orange 7006
prussian green 7009

	Kg	5,20	m ³	0,097 (0,39x0,36x0,69)	9401.80.00
		3,20			

Test:

Back stability, UNI EN 1729-2:2006
Seat and back static load test, UNI EN 1729-2:2006

Front stability, UNI EN 1729-2:2006
Sideways stability, UNI EN 1729-2:2006



The mark of
responsible forestry

Rocky

design marc newson

Rocking horse.
In polyethylene. Rein in natural hemp rope.

MT310

Matt colours:
brown 1069 C
white 1736 C
black 1768 C

1	Kg	14,40	m ³	0,354 (0,97x0,5x0,73)
		12,40		3926.40.00

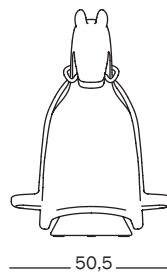
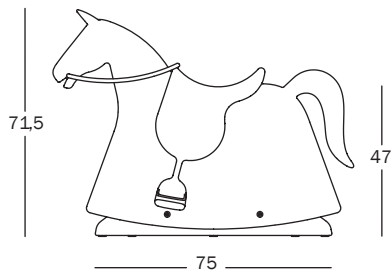
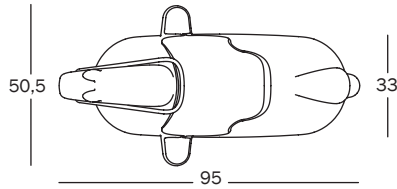
**Test:**

Flammability, EN 71-2:2011
Standard consumer safety specification for toy safety ASTM F963-11

Mechanical and physical properties, EN 71-1:2011

Seggiolina Pop

design enzo mari

Children's chair.
In sintered expanded polypropylene.

MT10

Matt colours:
orange 1082 C
blue 1606 C
green 1638 C

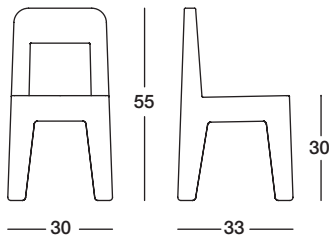

4	Kg	4,70	m ³	0,161 (0,64x0,4x0,63)
		0,86		9401.80.00

Test:

Back fatigue test, ENV 1729-2
Back stability, ENV 1729-2
Front stability, ENV 1729-2
Leg sideways static load test, ENV 1729-2
Seat impact test, ENV 1792-2
Sideways stability, ENV 1729-2

Back impact test, ENV 1729-2
Back static load test, ENV 1729-2
Leg forward static load test, UNI 10977:2000
Seat fatigue test, ENV 1729-2
Seat static load test, ENV 1729-2
Vertical impact test, ENV 1729-2

Summer To Spring

design el ultimo grito

Collection of children's clothes.
100% made in Italy.

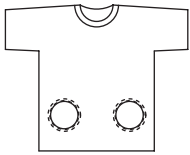

TWO
T-Shirt in cotton.
Short sleeves.

MT100 Small (2 to 3 years)
Medium (4 to 5 years)
Large (6 to 7 years)

	Kg	0,60	m ³	0,023 (0,29x0,35x0,23)
		0,25		6111.90.90



ABC
T-Shirt in cotton.
Short sleeves.

MT102 Small (2 to 3 years)
Medium (4 to 5 years)
Large (6 to 7 years)

	Kg	0,60	m ³	0,023 (0,29x0,35x0,23)
		0,25		6111.90.90

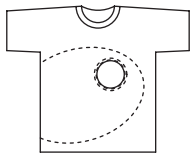

SINGLE
T-Shirt in cotton.
Short sleeves.

MT104 Small (2 to 3 years)
Medium (4 to 5 years)
Large (6 to 7 years)

	Kg	0,60	m ³	0,023 (0,29x0,35x0,23)
		0,35		6111.90.90



COLOURS
T-Shirt in cotton.
Short sleeves.

MT106 Small (2 to 3 years)
Medium (4 to 5 years)
Large (6 to 7 years)

	Kg	0,60	m ³	0,023 (0,29x0,35x0,23)
		0,35		6111.90.90

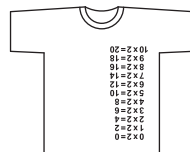

TIMES TABLE
T-Shirt in cotton.
Short sleeves.

MT108 Small (2 to 3 years)
Medium (4 to 5 years)
Large (6 to 7 years)

	Kg	0,60	m ³	0,023 (0,29x0,35x0,23)
		0,35		6111.90.90



NUMBERS
T-Shirt in cotton.
Short sleeves.

MT110 Small (2 to 3 years)
Medium (4 to 5 years)
Large (6 to 7 years)

	Kg	0,60	m ³	0,023 (0,29x0,35x0,23)
		0,35		6111.90.90

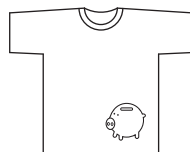

PIGGY BANK
T-Shirt in cotton.
Short sleeves.

MT112 Small (2 to 3 years)
Medium (4 to 5 years)
Large (6 to 7 years)

	Kg	0,60	m ³	0,023 (0,29x0,35x0,23)
		0,35		6111.90.90

Summer To Spring

design el ultimo grito

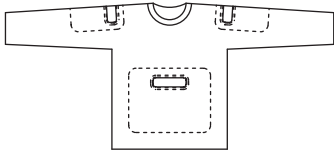

BICEPS
T-Shirt in cotton.
Long sleeves.

MT114 Small (2 to 3 years)
Medium (4 to 5 years)
Large (6 to 7 years)

	Kg	0,80	m ³	0,023 (0,29x0,35x0,23)	6111.90.90
		0,35			

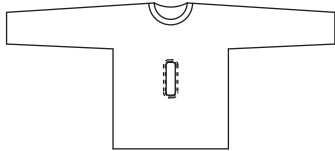

ALIEN
T-Shirt in cotton.
Long sleeves.

MT116 Small (2 to 3 years)
Medium (4 to 5 years)
Large (6 to 7 years)

	Kg	0,80	m ³	0,023 (0,29x0,35x0,23)	6111.90.90
		0,35			

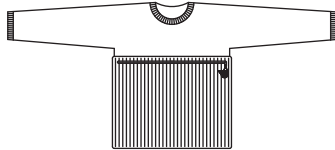

MICHELIN
T-Shirt in cotton.
Long sleeves.

MT118 Small (2 to 3 years)
Medium (4 to 5 years)
Large (6 to 7 years)

	Kg	0,80	m ³	0,023 (0,29x0,35x0,23)	6111.90.90
		0,35			

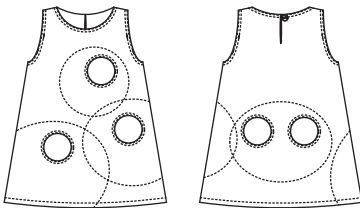

DRESS
Denim dress.
98% cotton, 2% lycra.

MT120 Small (2 to 3 years)
Medium (4 to 5 years)
Large (6 to 7 years)

	Kg	0,80	m ³	0,023 (0,29x0,35x0,23)	6111.90.90
		0,35			

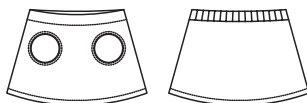

SKIRT
Denim skirt.
98% cotton, 2% lycra.

MT122 Small (2 to 3 years)
Medium (4 to 5 years)
Large (6 to 7 years)

	Kg	0,70	m ³	0,023 (0,29x0,35x0,23)	6111.90.90
		0,35			

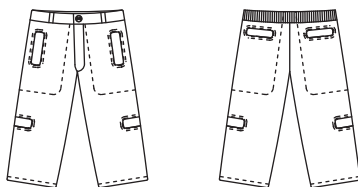

TROUSERS
Denim trousers.
98% cotton, 2% lycra.

MT124 Small (2 to 3 years)
Medium (4 to 5 years)
Large (6 to 7 years)

	Kg	0,80	m ³	0,023 (0,29x0,35x0,23)	6111.90.90
		0,35			

Trioli

design eero aarnio

Compasso d'Oro 2008

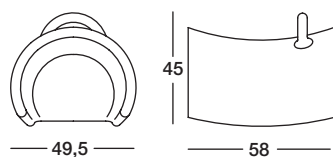
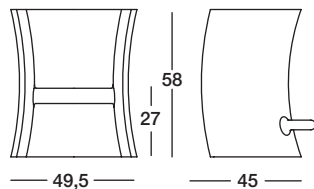
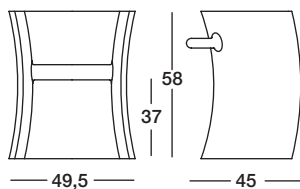

Children's chair.
In polyethylene. Two different seat heights.
It can also be used as a rocker.
! Suitable for outdoor use.

MT15

Matt colours:
red 1004 C
blue 1252 C
yellow 1665 C
white 1700 C

Test:

Back fatigue test, ENV 1729-2
Back stability, ENV 1729-2
Chemical properties, EN 71-3:1994
Front stability, ENV 1729-2
Leg sideways static load test, ENV 1729-2
Seat fatigue test, ENV 1729-2
Seat impact test, ENV 1729-2
Sideways stability, ENV 1729-2

1	Kg	7,70	m ³	0,14 (0,51x0,47x0,59)	9401.80.00
		6,70			

Back impact test, ENV 1729-2
Back static load test, ENV 1729-2
Flammability, EN 71-2:2003
Leg forward static load test, UNI 10977:2000
Mechanical and physical properties, EN 71-1:1998
Seat front edge durability test, ENV 1729-2
Seat static load test, ENV 1729-2
Vertical impact test, ENV 1729-2

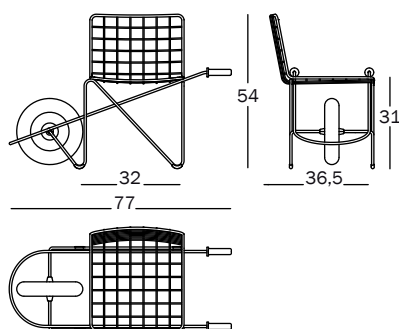

Children's chair.
Frame in steel rod painted in polyester powder.
Wheel and handles in polypropylene.

MT26

Frame: green
Wheel: orange

1	Kg	4,90	m ³	0,215 (0,83x0,44x0,59)	9401.79.00
		3,40			

Tuttifrutti

design stefano giovannoni

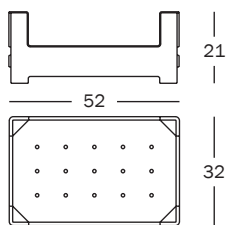

Stacking basket.
In SAN. Can be supplied with wheels.

AC26

Transparent colours:
orange 2510 TR
blue 2530 TR

	Kg	7,50	0,138 (0,52x0,53x0,5)	3926.90.97
		1,75		

Optional for AC26.
Set of 4 wheels in polyamide with cover in rubber. Ø 60 mm.

AC28

Matt colours:
orange
blue

	Kg	0,30		3926.90.97
		0,20		

Villa Julia

design javier mariscal

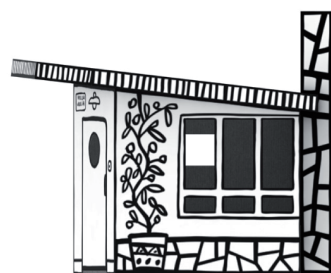

Small cardboard house.
Complete with stickers for personalization.

MT220

Matt colour:
white

	Kg	8,40	0,132 (1,5x1,1x0,08)	9503.00.99	
		6,40			





Magis cross_referenze (Plastic)



Alma

Matt

	1037 C RAL 1034 giallo yellow
	1342 C PANTONE 376 M verde green
	1478 C RAL 8012 marrone brown
	1690 C RAL 9016 bianco white



Bunky

Matt

	1218 C PANTONE 2985 C blu chiaro light blue
	1226 C blu blue
	1232 C PANTONE PROCEDURAL BLUE C blu scuro dark blue
	1652 C PANTONE 714 C arancio chiaro light orange
	1654 C arancio orange
	1656 C PANTONE 717 C arancio scuro dark orange
	1736 C RAL 9003 bianco white



Dodo

Matt

	1004 C RAL 3028 rosso red
	1025 C RAL 1007 giallo yellow
	1252 C PANTONE 300 M blu blue
	1735 C RAL 9010 bianco white



Downtown

Matt

	1736 C RAL 9003 bianco white
--	---



El Baul

Matt

	1700 C RAL 9002 bianco white
--	---



Eur

Matt

	1092 C PANTONE 167 M terracotta terracotta
	1606 C PANTONE 653 M blu blue



Happy Bird

Matt

	1085 C PANTONE 7417 M arancio orange
	1665 C RAL 1023 giallo yellow
	1735 C RAL 9010 bianco white



Julian

Matt

	1122 C RAL 3031 rosso red
	1290 C PANTONE 361 M verde green
	1665 C RAL 1023 giallo yellow
	1735 C RAL 9010 bianco white



Ladriillos

Matt

	1006 C RAL 4010 fucsia fucsia
	1025 C RAL 1007 giallo yellow
	1085 C PANTONE 7417 M arancio orange
	1220 C PANTONE 292 M azzurro sky blue
	1252 C PANTONE 300 M blu blue
	1281 C RAL 6000 verde scuro dark green
	1360 C PANTONE 375 M verde green
	1623 C PANTONE 688 M rosa pink

The printing ink and the screen visualization cannot exactly reproduce the colours. For higher accuracy we suggest inspecting the colour samples.



Le Chien Savant

Matt	1315 C	NCS 0560 G50Y
	verde green	
	1569 C	NCS 0540 G80Y
	giallo yellow	
	1628 C	NCS 0510 Y80R
	rosa pink	
	1647 C	NCS 0560 Y60R
	arancio orange	
	1735 C	NCS S 0300 N
	bianco white	



Linus

Matt	1690 C	RAL 9016
	bianco white	



Mico

Matt	1004 C	RAL 3028
	rosso red	



Nido

Matt	1025 C	RAL 1037
	giallo yellow	
	1290 C	PANTONE 361 M
	verde green	
	1420 C	RAL 7016
	grigio antracite grey anthracite	



Flying Carpet

Matt	1700 C	RAL 9002
	bianco white	



Seggiolina Pop

Matt	1082 C	PANTONE 1645 M
	arancio orange	
	1606 C	PANTONE 653 M
	blu blue	
	1638 C	PANTONE 7488 M
	verde green	



Paradise Tree

Matt	1001 C	RAL 2004
	arancio orange	
	1004 C	RAL 3028
	rosso red	
	1220 C	PANTONE 292 M
	blu chiaro light blue	
	1360 C	PANTONE 375 M
	verde green	
	1665 C	RAL 1023
	giallo yellow	
	1735 C	RAL 9010
	bianco white	



Piedras

Matt	1407 C	RAL 7016
	grigio antracite grey anthracite	



Pingy

Matt	1735 C	RAL 9010
	bianco white	
	1763 C	RAL 9017
	nero black	



Puppy

Matt	C	dalmata dalmatian
	1001 C	PANTONE ORANGE 021 M
	arancio orange	
	1360 C	PANTONE 375 M
	verde green	
	1700 C	RAL 9002
	bianco avorio ivory white	



Rocky

Matt	1069 C	RAL 8017
	marrone brown	
	1736 C	RAL 9003
	bianco white	
	1768 C	RAL 9017
	nero black	



Trioli

Matt	1004 C	RAL 3028
	rosso red	
	1252 C	PANTONE 300 M
	blu blue	
	1665 C	RAL 1023
	giallo yellow	
	1700 C	RAL 9002
	bianco white	



Trotter

Matt	1089 C	RAL 2004
	arancio orange	
	1283 C	RAL 6002
	verde green	

