

MFC PEDESTALS

— By Actiu —



■ GENERALES FEATURES MELAMINE PEDESTALS

		GENERALES FEATURES MELAMINE PEDESTALS
STRUCTURAL FEATURES	Material	Chip wood board divided in three layers, particle board with pressed synthetic resins in hot temperature. Sanding. Density 630 Kg/m ³ . Covered with mfc decorative paper. (Different thicknesses: 16 y 19 mm).
	Structure	Chip wood board covered with MFC decorative paper, 19 mm thickness and 650 Kg/m ³ density.
	Drawer	Monoblock drawer, thermoplastic moulded. High resistance. Divider and pencil tray included.
	Bottom filing drawer	Multipurpose bottom part. Thermoplastic moulded. Support extra castor,
	Locking system. Security	Anti-tilt mechanism included in lock system. Security system to avoid opening more than two drawers at the same time.
	Interchangeble locks	Two position lock. Closed and locked. 1 key available to provide maximum security.
	Castors	Standard castors. Only for mobile pedestals.
	5th castor for filing drawer	Better stability and functionality. Only available in mobile pedestals. Desk heigh pedestals don't need it.
	Gently movements. Soundproofing	Polyamide locking bar to provide silent movements. Runners Stop made of rubber.
	Slides type	Steel telescopic ball bearing slides for total extraction or Steel telescopic precision linear slides for total extraction.
Slides	Telescopic ball bearing slides made of steel, total extraction, pre-galvanized treatment, passivated and electrolytic sealed salt atmosphere resistant. Steel telescopic precision linear slides for total extraction.	
COMPLEMENTARY FEATURES	Handles	Ergonomics. Zamak moulded(zinc, aluminium, magnesium, copper alloy) Silver finish.
	Dividers	Thermoplastic material. High resistant.
	Pencil tray	Thermoplastic material. High resistant.
	Frame	Metal frame suitable for all type of files.
	Tops	Materials and thickness as per the models (Mobile pedestals; Chipboard tops covered by MFC paper, 16 mm thickness and 630kg/m ³ density) MFC 16, 19, 25 o 30 mm thickness, High pressure laminate 25 mm. thickness or compact laminate 13 mm thickness.
	Drawer and filing drawer fronts	Chipboard wood board covered by MFC paper 16 mm thickness and 650kg/m ³ with PVC edges 2 mm thickness.
LAYERS FEATURES	Scratches resistance (UNE EN 14323)	≥ 1,5 N
	Spot resistance (UNE EN 14323)	≥ Grade 3. Non visible defects
	Exhaustion resistance (UNE EN 14323)	≥ Grade 3. Resistant
	Surface aspect (UNE EN 14323)	Silk texture, mate finish. Grade 4
	Edges damages (UNE EN 14323)	≤ 10 mm/m
	Points fault (UNE EN 14323)	≤ 2 mm ² /m ²
	Scratches faulty (UNE EN 14323)	≤ 20 mm ² /m ²
	Covering	Decorative paper covered by resistant melamine, specially for horizontal aplicacions. Non fingerprints
	Covering thickness (UNE EN 14323)	Standard thickness = 120 gr. Perfect product to be used in surfaces with a constant use
	Resistance to agresive home cleaning products without solvent (UNE EN 14323)	Good resistance to acids, alcals and room temperature oils
	Resistance to spots (UNE 14323)	Without visible defects
	Maintenance	Easy to clean. Use PH neutral products



■ FEATURES

- 1 MFC top 16 mm thickness
- 2 Side panels 16 mm thickness
- 3 Anti-tilt mechanism system. Drawer blocked system for transport
- 4 Open-close position lock
- 5 Drawers and filing drawer with total extraction
- 6 Silent movements. Rubber runner-stop
- 7 Polyamide lateral locking bar
- 8 Standard castors.
- 9 5th castor for filing drawer to give more stability and functionality
- 10 Different combinations all in one colour or silver side panels with a colour
- 11 **Optional** pencil trays and dividers
- 12 **Optional** laminated security glass top PVB 5+5 mm thickness
- 13 Silver aluminium handles

■ MOBILE PEDESTALS PROGRAMME WITH TELESCOPIC RUNNERS. COMPLETE EXTRACTION OF THE DRAWER

- Accurate metal runners
- Monoblock plastic drawer with stationery tray (includes dividers)
- Models with filing drawer with a metal filing frame for A4 files
- Models with filing frame fo A4 and Folio

ALL DRAWERS

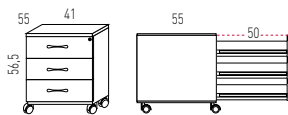

DRAWER + FILING DRAWER INCLUDING FRAME

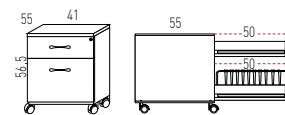

DRAWER + PULL OUT FILING FRAME

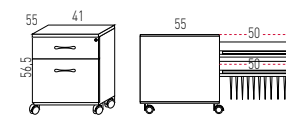

■ MOBILE PEDESTAL PROGRAMME WITH TELESCOPIC RUNNERS. DRAWER PARCIALLY OPENED.

- Simple metal runners with wheels
- Filing drawer with stationery tray
- Models with filing drawer with a metal filing frame for A4 files

ALL DRAWERS

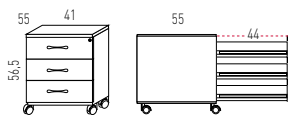

DRAWER + FILING DRAWER INCLUDING FRAME

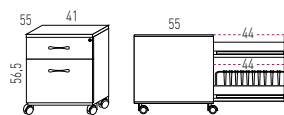

■ FINISHES (see finishes card)

MELAMINE (MFC) - 1 COLOUR

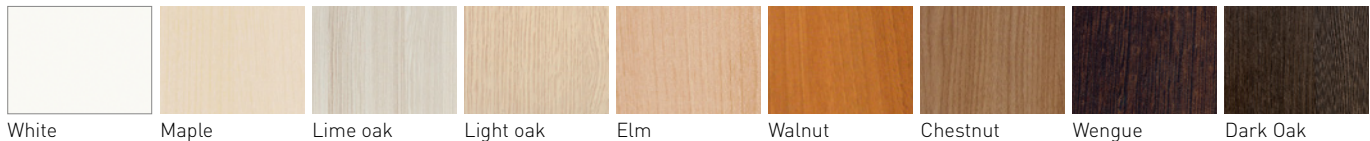

MELAMINE (MFC) - 2 COLOURS

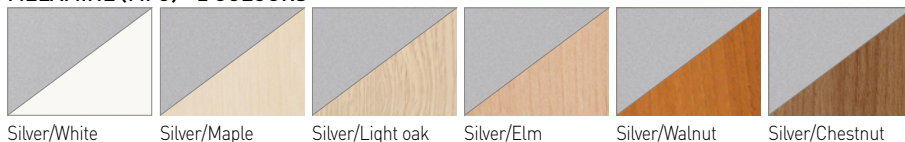

Aluminium Handle:
 - White MFC: White Handle.
 - Rest of MFC finishes: Aluminium Handle



■ FEATURES

- 1 MFC top 25 mm thickness, MFC plus top 30 mm thickness or High pressure laminate top 25 mm thickness
- 2 MFC side panels 16 mm thickness
- 3 Anti-tilt mechanism system
- 4 Open-close position lock
- 5 Drawer blocked system
- 6 Drawers and filing drawer with total extraction
- 7 Silent movements. Rubber runner-stop.
- 8 Polyamide lateral locking bar
- 9 4 inner levelers. Easy access. Distance up to +20 mm
- 10 **Optional** pencil trays and dividers
- 11 Silver aluminium handles

■ DESK HEIGHT PEDESTALS WITH TELESCOPIC RUNNERS. COMPLETE EXTRACTION OF THE DRAWER PROGRAMME

- Accurate metal runners
- Monoblock plastic drawer with stationery tray (includes dividers)
- Models with filing drawer with a metal filing frame for A4 files
- Models with filing frame fo A4 and Folio

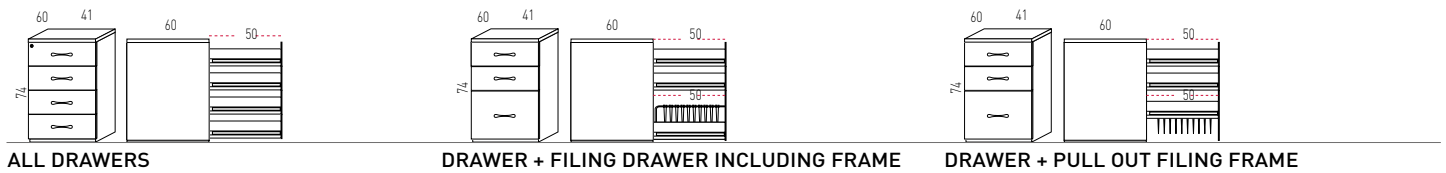

ALL DRAWERS

DRAWER + FILING DRAWER INCLUDING FRAME

DRAWER + PULL OUT FILING FRAME



ALL DRAWERS

DRAWER + PULL OUT FILING FRAME

■ FINISHES

MELAMINE (MFC) - 1 COLOUR

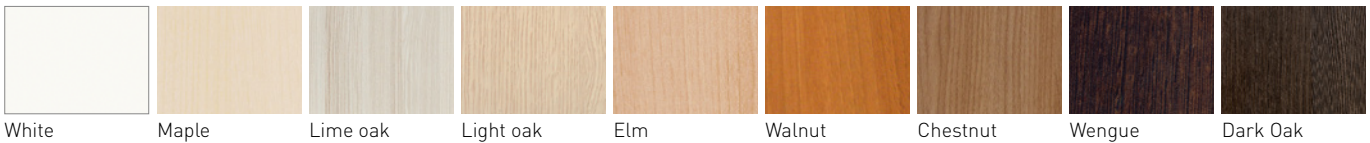

White Maple Lime oak Light oak Elm Walnut Chestnut Wengue Dark Oak

MELAMINE (MFC) - 2 COLOURS

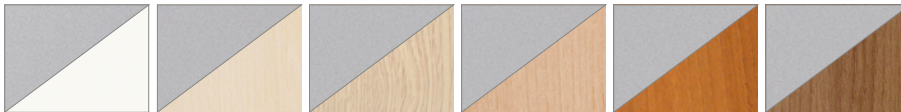

Silver/White Silver/Maple Silver/Light oak Silver/Elm Silver/Walnut Silver/Chestnut

(see finishes card)



Aluminium Handle:
 - White MFC: White Handle.
 -Rest of MFC finishes: Aluminium Handle

PERSONAL STORAGE UNITS – 113CM HEIGHT PEDESTAL

Model with shelves

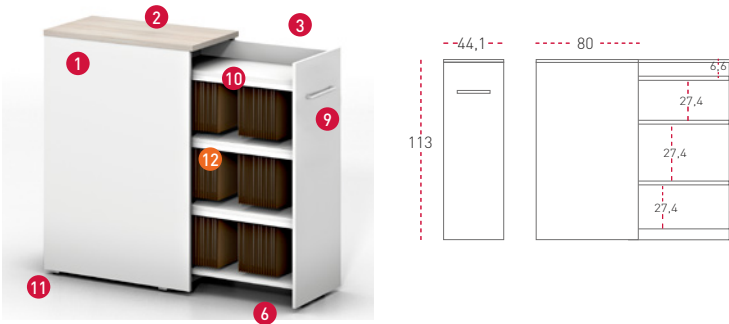

Model with shelf and drawers

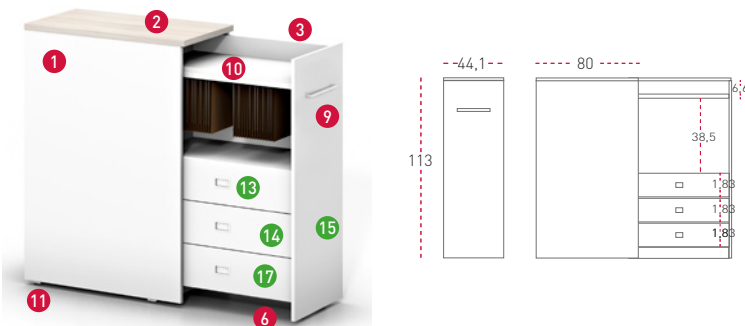

Model with shelf + drawer + filing drawer

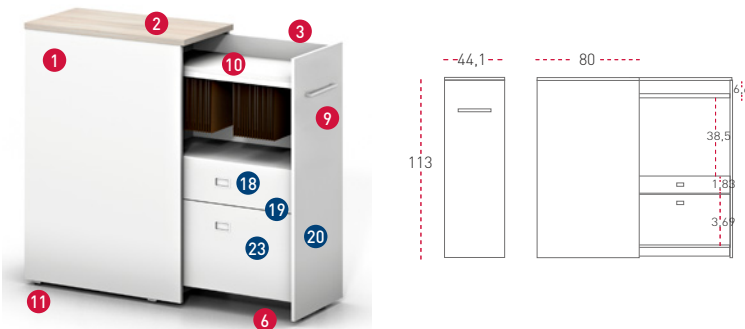

FEATURES

All models

- 1 Storage unit carcass made of 19mm thick MFC (front and back panel 16mm thick)
- 2 Top and bottom shelves made of 25mm thick MFC
- 3 Pull out module using full extraction runners (maximum extraction: 70cm)
- 4 Reinforced module to increase stability when the unit is opened.
- 5 Smooth and silent closing runners
- 6 35mm diameter black castor to allow easy opening of the module
- 7 Lock included
- 8 Smooth and silent closing runners (soft/self-closing runners available as an option)
- 9 Zamak handle on door. White finish.
- 10 Soft/self-closing runners available as an option
- 11 Anti humidity feet with levellers. Black Finish

Model with shelves

- 12 Height adjustable steel shelves 0.8mm thick with double lower rail to allow hanging files

Model with Shelf and drawers

- 13 Inset Zamak handle on drawers. White finish.
- 14 Completely accessible drawers
- 15 Full extraction runners on drawers
- 16 Black steel drawer case 0.7mm thick.
- 17 16mm thick MFC drawer fronts

Model with Shelf + drawer + filing drawer

- 18 Inset Zamak handle on drawers. White finish.
- 19 Completely accessible drawers and filing drawer
- 20 Full extraction runners on drawers
- 21 Black steel filing drawer case 0.7mm thick.
- 22 Metal adapter included to use different sizes of files on filing drawer
- 23 16mm thick MFC drawer and filing drawer fronts

FINISHES (see finishes card)

MELAMINE (MFC)

Carcass, Door and Drawers



White

Top



White



Lime Oak



Chestnut

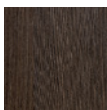

Dark Oak



Aluminium Handle:

- White MFC: White Handle.

- Rest of MFC finishes: Aluminium Handle

ALL METAL



White

PULL OUT PEDESTALS WITH METAL DRAWER AND RUNNERS

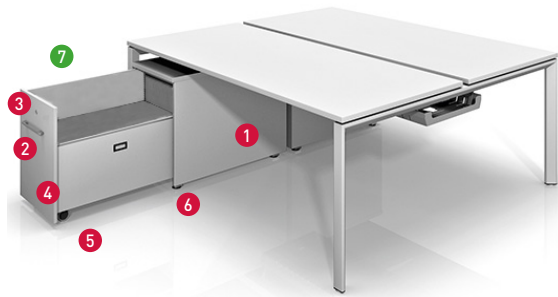

■ FEATURES

- 1 MFC structure available in different finishes. Square caps with levelers.
- 2 Large handle.
- 3 Security key.
- 4 Totally extractions runners
- 5 Pedestal drawer, soft castors, 37mm diameter. Lockable.
- 6 Square caps with levelers.
- 2 models:
 - 7 Top shelf + Black steel filing drawer case 0.7mm thick. with stabilizing runner. Inlaid handles
 - 8 Top shelf + 2 Black steel drawers case 0.7mm thick.. Optional dividers. Inlaid handles.



LAYOUT EXAMPLES

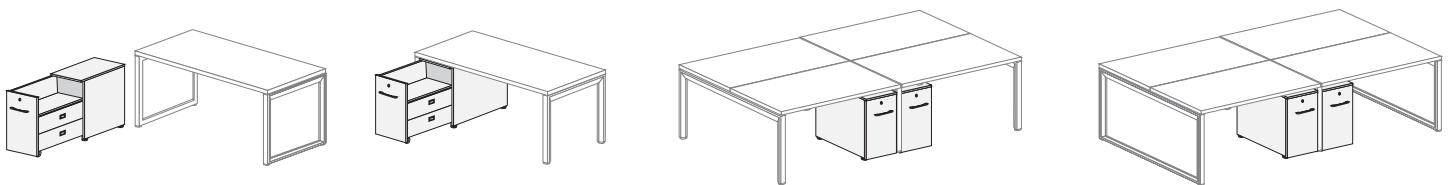

To use pull out pedestals as a desk support, please check VITAL PLUS ST operative desks range to see all available models.

To use pull out pedestals under the desks with other accessories such as modesty panels, electrification channels and so on, please check first with sales team to be sure that all accessories and sizes ordered are the correct ones.

■ FINISHES

MELAMINE (MFC) - 1 COLOUR

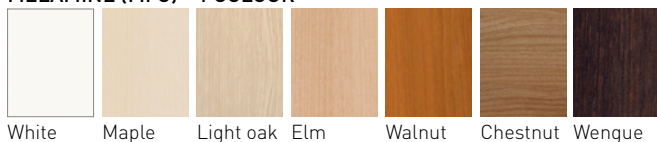

Aluminium Handle:
 - White MFC: White Handle.
 -Rest of MFC finishes: Aluminium Handle

STORAGE UNITS



- ① Sliding door
- ② Integrated runner system, Surface totally usable Embossed handles
- ③ Height adjustable shelves each 32 mm
- ④ Fitted handles by injected aluminium
- ⑤ Drawers with total extraction
- ⑥ Optional: Steel side by 2 mm thickness
- ⑦ Cable access \varnothing 58 cm

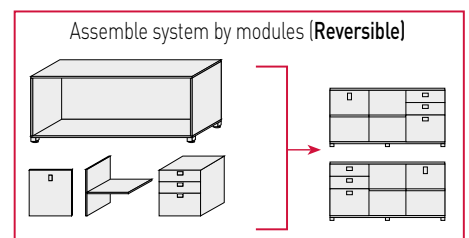

■ **STORAGE UNITS**

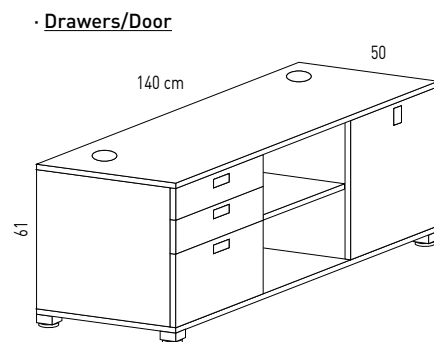
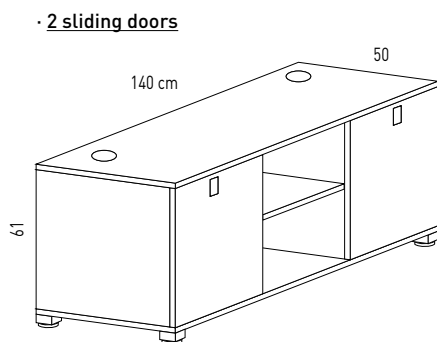

■ **HUTCH IN OPTION**

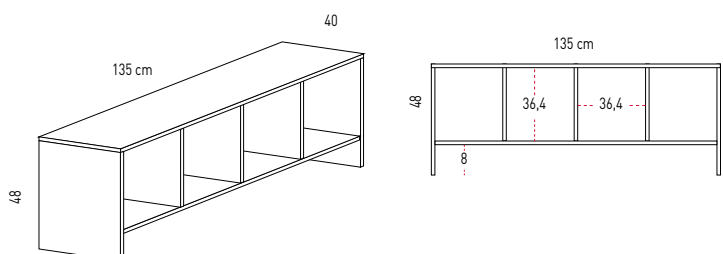

■ STORAGE UNITS

MFC frame composed by reversible modular system with shelves, sliding doors and or drawers and filing drawers. Two different models:

· Model with shelves and sliding doors

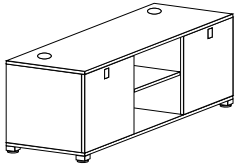

- 1 Top and base, 25 mm thickness
- 2 Inner side panels, mfc 19 mm thickness. Back panel 16 mm thickness
- 3 Shelves are manufactured by mfc 16 mm thickness. Height adjustable every 32 mm
- 4 Ergonomic handles produced with Zamak, aluminium alloy.
- 5 Levelers supports, inner easy access +20 mm
- 6 Anti skid PVC cap included in the levellers
- 7 2 cable access Ø80 mm, PVC top cover
- 8 MFC sliding door 16 mm thickness
- 9 Thermoplastic runner inserted in the base. Plane base without any obstacle

· Model with shelves and sliding doors

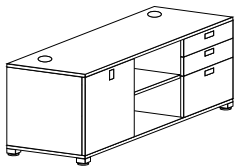
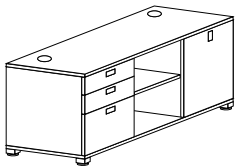

- 1 Top and base, 25 mm thickness
- 2 Inner side panels, MFC 19 mm thickness. Back panel 16 mm thickness
- 3 Shelves are manufactured by mfc 16 mm thickness. Height adjustable every 32 mm
- 4 Ergonomic handles produced with Zamak, aluminium alloy.
- 5 **Drawers:** Top security lock. Two positions, open and close. An unique key.
- 6 Levelers supports, inner easy access +20 mm
- 7 Anti skid PVC cap included in the levellers
- 8 2 cable access Ø80 mm, PVC top cover
- 9 Drawers and filing frames with MFC front panel 16 mm thickness
- 10 Drawers and filing frames with telescopic steel runners totally opened
- 11 Anti tilt mechanism (avoiding to open all drawers at the same time)

· Optional hutches for desk-support credenza units.

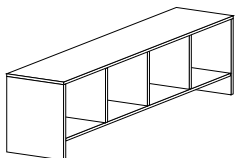

- 1 Optional hutch manufactured by MFC 19 mm thickness. Inner space 36,4 x 36,4 cm

■ FINISHES

MFC



White
(see finishes card)

Lime Oak

Maple

Chestnut

Dark Oak

Wengue

Wengue [19] finish will be discontinued in Vital Plus program at the end of this year.



Aluminium Handle:
- White MFC: White Handle.
-Rest of MFC finishes: Aluminium Handle



MATERIALS

Maximum use of materials to eliminate and minimize scraps. Use of recyclable and recycled materials in those components that do not affect the functionality and durability.

62,06%
RECYCLED
MATERIALS



PRODUCTION

Maximum optimization of energy use. Minimal environmental impact. Last generation technological systems. Zero discharge of wastewater. No VOC coatings. Processes free of heavy metals, phosphates, OC and COD.

100%
RECYCLABLE
ALUMINIUM, STEEL
& WOOD



TRANSPORT

Detachable systems. Volumes that facilitate the optimization of space. Maximum reduction of energy consumption by transport.

100%
RECYCLABLE
PACKAGE AND THINNER
FREE



USE

Quality and warranty. Long lasting. Replacements available.

EASY
TO CLEAN
AND MAINTAIN



DISPOSAL

Waste reduction. Supplier-manufacturer packaging reuse system. Components are easy to be separated. Inks in packaging are water-based, without solvents.

94,49%
RECYCLABLE
MATERIALS

■ **CERTIFICATES AND REFERENCES**

The different programmes get points in different environmental categories to get the LEED certificate (sustainability, material and resources, water, energy and atmosphere, inner environment quality, innovation and design).



The mark of responsible forestry



PEFC Certificate



EN ISO 14006:2011
ECODESIGN Certificate



UNE-EN ISO 9001:2008
ISO 9001 Certificate



UNE-EN ISO 14001:2004
ISO 14001 Certificate



E1 Certificate
by EN 13986



ACTIU TECHNOLOGY PARK
LEED® PLATINUM certified by USGBC
Leadership in Energy & Environmental Design
LEED® Gold certified 2011 - LEED® Platinum certified 2017

■ **STANDARS**

PEDESTALS MELAMINE has passed tests done in our technical department as well as the tests done in **AIDIMA** the Technological Institute for furniture. The tests correspond to **UNE** standards and Filing system cabinets:

- **UNE: EN14073-2:05.** Office furniture. Tables and desks and storage furniture. Safety requirements.
- **UNE: EN 14073-3:05.** Office furniture. Tables and desks and storage furniture. Test methods for the determination of stability and strength of the structure.
- **UNE: EN 14074:05.** Office furniture. Tables and desks and storage furniture. Test methods for the determination of strength and durability of moving parts.