

Polder

Hella Jongerius, 2005/2015

vitra.



Polder

In the home country of Dutch designer Hella Jongerius, the word 'polder' refers to low-lying flatlands, typically subdivided into fields serving various agricultural purposes, that have been reclaimed from the sea by means of dykes and drainage canals. With their flat surfaces, low-slung body and horizontal emphasis, both Polder sofas evoke the characteristic features of the polder landscape.

The large seat cushions of the Polder Sofa and Polder Compact form an extremely comfortable, asymmetrical seating surface that is flanked on both sides by the upholstered body. The shape of the body is what distinguishes the two sofas: a low armrest is integrated on one end of the Polder Sofa, while the other is bordered by an adjoining platform that also serves as a storage surface for magazines, books or trays. The Polder Sofa thus offers plenty of space to stretch out and relax, whether sitting or lying down. The Polder Compact, by contrast, features a body with two armrests in different heights, which demarcate the smaller dimensions of the sofa. The higher armrest also makes it possible to sit comfortably in a sideways position – either for reading or watching television.

With their distinctively asymmetrical structure, both Polder sofas can be optionally configured with the higher armrest on the left or right side, making them adaptable to different spatial settings. Since the platform for the Polder Sofa is separately available, it can also be used as an ottoman.

The upholstered cushions and body of the sofas are covered with fabrics in carefully coordinated hues and weaves: shades of green, red, golden yellow or night blue. In place of standard upholstery fabrics, textiles developed exclusively for Vitra by Hella Jongerius are used as cover materials – thereby intensifying the subtle interplay of colours and textures that typifies the design.

Materials

- **Structural frame:** wooden frame.
- **Seat cushions:** polyurethane foam with interactive pocket spring core, chamber cushions and polyester fleece.
- **Back cushions:** polyurethane foam with polyester fleece and chamber cushions.
- **Armrest cushion:** detached bolster, freely positionable, sand-weighted.
- **Cover:** coordinated combinations of various colours and fabric types, removable.
- **Ottoman:** wooden frame with polyurethane foam.

1	Polder	5	Polder Ottoman	9	Useful facts
2-3	Polder Sofa	6-7	Fabrics and colours	10	Flexible options with the Ottoman
4	Polder Compact	8	Upholstery construction	11-12	Accessories

The distinctive character of the Polder Sofa by Hella Jongerius derives from the combination of diverse fabrics and colours, an asymmetrical shape and charming details. Available in coordinated shades of red, green, golden yellow or night blue, this comfortable sofa adds a striking accent to any interior.

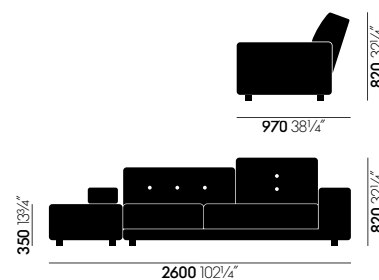

Polder Sofa golden yellow



Polder Sofa green

**Hella Jongerius**

The Dutch designer Hella Jongerius lives and works in Berlin. She founded the Jongeriuslab studio in 1993 and began collaborating with Vitra in 2004. Since then, she has not only contributed a substantial number of designs to the continually expanding Vitra Home Collection, but has also applied her expertise in the realm of colours and materials to the Vitra Colour & Material Library.

**Polder Sofa red****Polder Sofa night blue**

Designed by Hella Jongerius in a range of fabrics and carefully coordinated hues and weaves, the Polder Compact sofa adds an eye-catching note to any interior. It is available in shades of green, red, night blue and golden yellow, and the compact dimensions of this sofa make it especially well suited for smaller apartments.

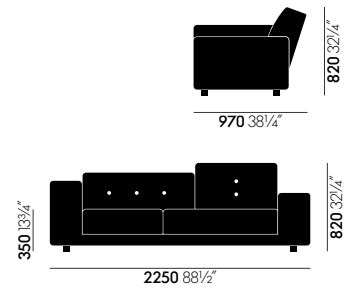

Polder Compact golden yellow



Polder Compact green

The Ottoman is a flexible element that can be optionally used as a side platform to extend the horizontal surface of the Polder Sofa. Positioned perpendicular to the sofa, it forms a chaise longue – and as an individual object it can be placed anywhere in the room to provide a practical seat or an extra surface for small items. The Ottoman comes in four predefined colours, which are perfectly coordinated with the respective colour schemes of the sofas.



Polder Compact red, Polder Ottoman red



Polder Compact night blue



Fabric mix golden yellow



32
Aura - chartreuse



11
Dumet - yellow melange



06
Maize - canary/ ochre



05
Volo - canola



06
Aura - canary



05
Panamone - curry





The buttons of the Polder sofas, designed by Jongerius in a collage of coloured plastic, aluminium and leather, are an especially striking detail. They not only provide an attractive contrast to the soft woven fabrics, but also facilitate removal of the upholstery covers for cleaning, thanks to a simple fastening device.



Polder button sets for the colour versions red, green, golden yellow and night blue

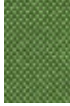

Fabric mix green

	62 Aura - emerald		09 Maize - fern/ brandy
	09 Aura - green		06 Volo - summer grass
	13 Dumet - green melange		34 Plano - grass green/forest







Fabric mix red

	15 Aura - cherry		11 Maize - poppy red/brandy
	16 Aura - flame red		77 Volo - brick
	12 Brink - bordeaux/ red		63 Plano - red/ poppy red

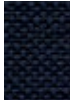

Fabric mix night blue

	57 Aura - dark blue		04 Twill - ink blue
	08 Credo - dark blue/black		11 Volo - night blue
	21 Laser - dark blue/ moor brown		16 Maize - night blue/ black

The upholstery construction of the Polder Sofa and Polder Compact provides excellent comfort. The seat elements, which rest on the structural frame, combine layers of polyurethane foam with a chamber cushion overlay and an interactive pocket spring core. The resilient pocket springs have a pleasant cushioning effect paired with high shape recovery. The backrest cushions consist of polyurethane foam and a chamber cushion.

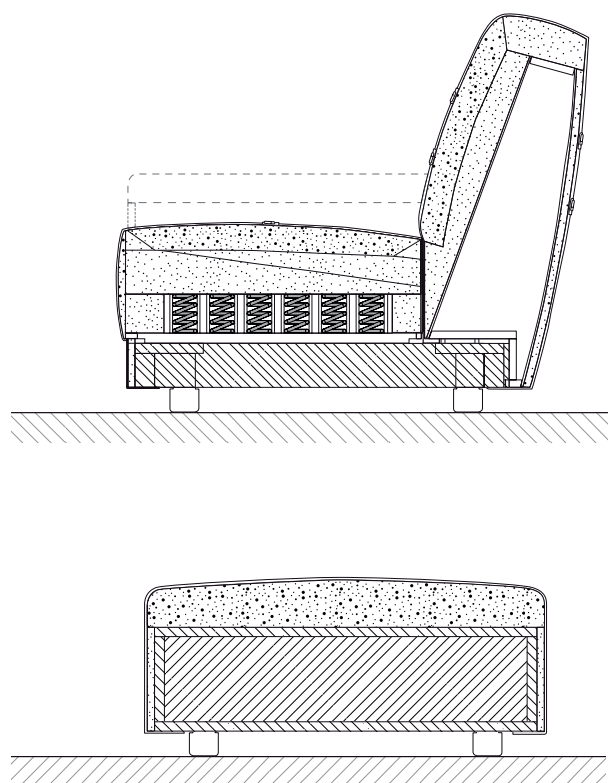

USEFUL FACTS ABOUT UPHOLSTERY

Vitra has produced upholstered furniture of the highest quality for over fifty years. Premium materials, a careful selection of cover materials, skilled craftsmanship and high quality standards at Vitra are a guarantee for outstanding products that bring lasting pleasure. In Vitra's own Test Centre, our upholstered furnishings are regularly subjected to rigorous tests that far exceed common standards.

Nevertheless, every piece of upholstered furniture requires proper care.

Maintenance:

Exposure to direct sunlight should be avoided, since ultraviolet rays can cause cover materials to fade.

To retain the original fullness and shape of your sofa, cushions should be vigorously shaken and plumped at regular intervals. Folds and creases from sitting can be prevented in all types of upholstery by smoothing the cover material after use.

Slight indentations in the seat and backrest are to be expected over time, but they will not diminish the quality of your sofa in any way. To maintain its uniform appearance and ensure that your sofa wears evenly, alternate the place where you sit – especially when the sofa is new.

After your sofa has experienced some use, the upholstery padding will retain a stable degree of firmness for the rest of its product life.

Cover materials have a decisive influence on the appearance and characteristics of upholstered furniture.

Technical properties such as resistance to abrasion, fading or stains play an important role along with the quality of fibres, type of weave and aesthetic features of the textile.

Function and performance are primarily determined by the type of fabric used. In general, synthetic fibres are superior to natural fibres in terms of their technical characteristics. For this reason, blends of different materials are employed to combine the advantages of the individual fibres.

In the following, you will find some of the key features of the textiles used by Vitra in its upholstery covers:

Cotton (CO)

Skin-friendly natural fibre of plant origin, pleasant tactile qualities, readily absorbs moisture. Often inferior to synthetic fibres with regard to colourfastness and light resistance; flat weaves susceptible to pilling.

Linen (LI)

Natural fibre of plant origin with slight lustre, cool and comfortable, repels dirt, no pilling. Limited colourfastness to light and crocking, creases easily.

Wool (WO)

Elastic natural fibre of animal origin, naturally self-cleaning – a brief airing disperses absorbed odours, leaving the wool smelling neutral and fresh again. Good resistance to light and abrasion, highly absorbent, minimal creasing, low flammability. Subject to pilling and matting.

Polyester (PE), Polyacrylic (PA), Viscose (VI)

Synthetic, highly uniform, lightfast fibres. The non-absorbent properties of synthetics can be mitigated with fibre blends and weaving techniques.

The overall look of a piece of furniture is influenced by the colour and type of cover fabric, its properties (elastic or non-stretch) as well as the upholstery technique (removable or attached covers). Consequently, a sofa can take on a different appearance depending on the cover material. Generally speaking, cover fabrics with some elasticity are less susceptible to creases and puckering, since they have an adaptable fit on three-dimensional forms. Heavier cover materials such as Laser or Credo drape more smoothly, while thinner materials exhibit a finer rippling effect.

Care instructions:

All Polder covers are removable. Fabric covers can be professionally dry cleaned. Please refer to the care instructions provided with your sofa.

Should you ever need to replace individual parts or covers due to wear and tear, please contact your local Vitra retailer.



Polder Sofa golden yellow, armrest left, sitting right

Polder Sofa golden yellow, armrest right, sitting left



Polder Sofa red, armrest right, sitting left

Polder Sofa red, armrest left, sitting right



Polder Compact green, low armrest right (viewed from front)



Polder Compact night blue, low armrest left (viewed from front)
Polder Ottoman green

The concept behind the Vitra Home Collection is not to promote a uniform 'design style', but rather to offer a selection of furniture and accessories that can be freely combined according to each customer's preferences. Here are a few suggestions for products and accessories in colour palettes which harmonise beautifully with the Polder Sofa.



Rise Table
ø 50 x 47.5 – 66 cm



Occasional Table LTR
39.2 x 33.5 x 25 cm



Prismatic Table
41 x 37.5 cm



Panton Junior
37.5 x 44.5 x 63 cm



Eames Elephant
78.5 x 41 x 41.5 cm



Hexagonal Table
51 x 44 x 41 cm



Hand
300 x 400 mm



Dove
300 x 400 mm



Couple
300 x 400 mm



Love, pink
400 x 400 mm



Love, red
400 x 400 mm



Quatrefoil pink
400 x 400 mm



Vases Berry
55 x 55 cm |
40 x 40 cm



**Repeat classic
Houndstooth Pink**
30 x 40 cm



Metal Side Table
31.5 x 31.5 x 38 cm | 40 x 40 x 44.5 cm |
31.5 x 70 x 35.5 cm



**Wall Clock
Sunburst Clock**
ø 47 cm



**Plywood Group
LCW**
53 x 56 x 68 cm



**Zoo Timer
Elihu the Elephant**
32 x 32 x 5 cm



Bovist 'Pottery'
ø 54 x 38 cm



**Zoo Timer
Fernando the Fish**
25 x 28 x 3.5 cm



**Layers Vineyard
Jade/Turquoise**
30 x 40 cm



**Repeat classic
Houndstooth Moss**
30 x 40 cm



Vases Goldenrod
55 x 55 cm
40 x 40 cm



**Repeat classic
Houndstooth Lemon**
30 x 40 cm



**Layers Vineyard
Ochre/White**
30 x 40 cm



NesTable
50 x 35 x 57.4 - 77 cm



Wool Blanket, Maze Pattern
200 x 135 cm²



Maze, mustard
40 x 40 cm



Plywood Group LCW
53 x 56 x 68 cm



Nelson Bench
122 x 47 x 35.5 cm | 183.5 x 47 x 35.5 cm



L'Oiseau
24.5 x 15 x 6 cm



Cork Family
ø 31 x 33 cm



Wool Blanket, Circle Sections
200 x 135 cm²



Small Dot Pattern Document
40 x 40 cm



Millerstripe multicolored neutral
40 x 40 cm



Repeat classic Houndstooth Cocoa
30 x 40 cm



Butterfly Stool
42 x 39 cm



Elliptical Table ETR
226.5 x 74.5 x 22.5 cm



Plate Table
40 x 40 x 37 cm | 70 x 70 x 37 cm |
120 x 40 x 37 cm | 120 x 70 x 37 cm



Splayed Leg Table
44 x 44 x 43.5 cm



Small Dot Pattern Document reverse
40 x 40 cm



Eyes
30 x 40 cm



Geometri black/white
40 x 40 cm



Maze (black)
40 x 40 cm



Snake (black)
40 x 40 cm



Checker black/white
40 x 40 cm

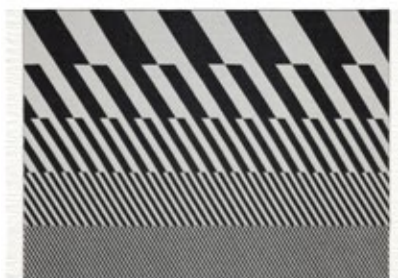

Wool Blanket, Diagonals
200 x 135 cm²



Wall Clocks Sunflower Clock, ø 75 cm



Asterisk Clock, ø 25 cm



Eames House Bird
28 x 8.5 x 27.5 cm

