



## Hack

Designed by Konstantin Grcic, Hack is a table system that anticipates the requirements of companies and employees – a provocative solution which can be understood as a ‚hack‘ of the office environment. Grcic counters traditional desks with an innovative functional and aesthetic approach that satisfies the demands of today’s high-tech companies. Such companies need to offer young university graduates an attractive, practical and creative work environment while also being able to respond to dynamic changes in their office structures.

With its raw wooden panels, Hack presents an unfinished aesthetic at first glance, like a snapshot of an experimental project under development. The system reflects the attitude of companies that similarly define themselves in terms of constant change. Each Hack unit forms an autonomous element whose adaptability allows it to satisfy various needs: companies value Hack for its flexibility, since it can be folded up into a practical, flat ‚box‘ in just a few simple steps. This makes Hack easy to dismantle and transport and enables space-saving storage. Individual users appreciate Hack’s expansive work surface, as well as its provision of a private sphere that can

be personalised. The height adjustment feature offers standing, sitting and lounge options and thus defines distinct niches for work, meetings and relaxation. Hack is not only functional and flexible, but is also fabricated in a manner that reflects the environmental priorities of young companies: thanks to its manually operated mechanism, the production and utilisation of Hack are ecologically sustainable. In addition, the tables are manufactured on site in an energy-efficient manner, with wooden parts that are locally produced and assembled by Vitra using prefabricated metal hardware.

The construction of Hack is robust and stripped down to the essentials. The solid hinges connecting the three wooden panels are precisely tooled metal parts that facilitate the clever folding function of Hack and simultaneously ensure its stability. The continuously variable height adjustment of the table top is manually operated with a recessed grip or a crank. Depending on the version, this feature makes it possible to adjust the table height within seconds from 300 to 1250 mm. In the lowest position, Hack can be outfitted with cushions for use as a sofa.

The computer-related term ‚hack‘ was coined in the late 1950s at MIT in Cambridge, Massachusetts. It describes a clever and resourceful solution devised by a hacker. A typical hack is quickly executed and often inelegant, but highly effective. It achieves the desired result without transforming the system architecture in which it is embedded, even though they often stand in contradiction to one another.

### Materials

- **Table top and wall elements:** OSB (oriented strand board), 15 mm thick, three-layered, flat-pressed panel made from micro veneers in accordance with DIN EN 300. Safety: all edges and corners are rounded. Emission levels are lower than the legally permissible (non-hazardous) E1 standard.
- **Frame:** welded construction made of square steel tubing, powder-coated finish in deep black.
- **Corner connectors:** anodised aluminium.
- **Legs:** powder-coated aluminium, finish in deep black, fitted with injection-moulded plastic glides for adaptation to uneven flooring (range 0-10 mm).
- **Straps:** polypropylene, black.

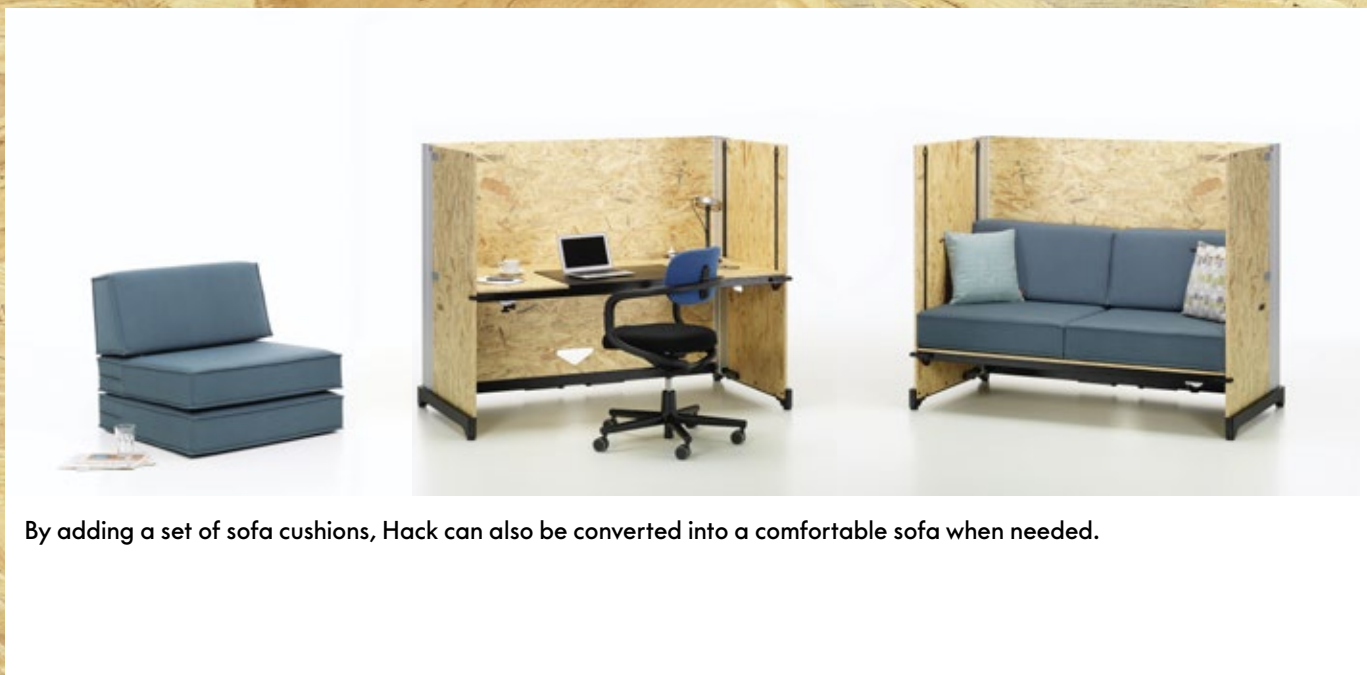

By adding a set of sofa cushions, Hack can also be converted into a comfortable sofa when needed.





**Hack version 1**  
Manual height adjustment with crank,  
height range 300 to 1250 mm



**Hack version 2**  
Manual height adjustment with quick adjustment,  
height range 700 to 1180 mm.



The practical folding mechanism enables space-saving storage – and the 'flat box' can be quickly transformed back into a valuable workstation in just seconds.





The handy transport wheels were designed specifically for Hack, allowing easy relocation or removal for storage.



The workstation can be comfortably equipped with optional table-top power sockets and active USB data connections.





The cable basket stretches under the entire table width, supporting socket extension leads and excess cable length. It is simply hooked onto the table top without any need for tools, and opens at the front for easy access to the cables below the table.



Hack has a simple, sturdy design, which is stripped down to the essentials. The solid hinges connecting the three wooden panels are precisely tooled parts made of anodised aluminium. These facilitate the ingenious folding function of Hack and simultaneously ensure its stability.





The table top's intuitive height adjustment feature is manually operated with a recessed grip or a crank. The height-adjustment belts are visible on the inside of the Hack wall elements, as a visual expression of the mechanics. Scaled markings on the belt indicate the table height. Safety brackets of matching colour are integrated into the table edging.

# Possible usage

Hack promotes flexibility and dynamism. Its adjustable features allow quick and spontaneous modifications, making Hack perfectly suited to environments with changing requirements. It can be transformed into a workstation, technology island, espresso bar, team base, meeting area, garage for mobile storage units or lounge, to name just a few options.



Storage Box

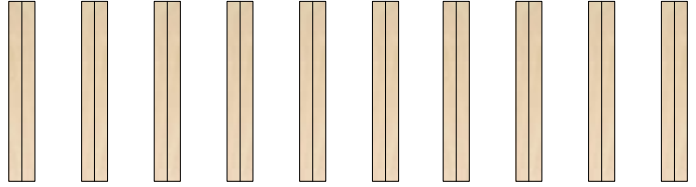

Workstation

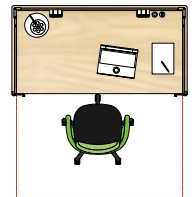
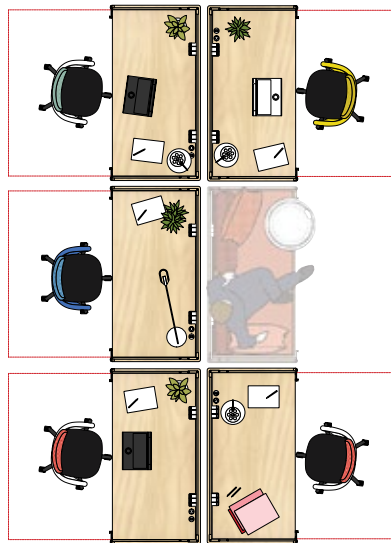

Workstation (high work)

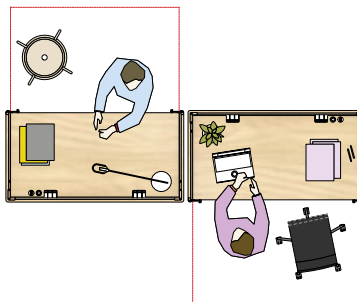
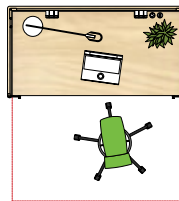





Technology station

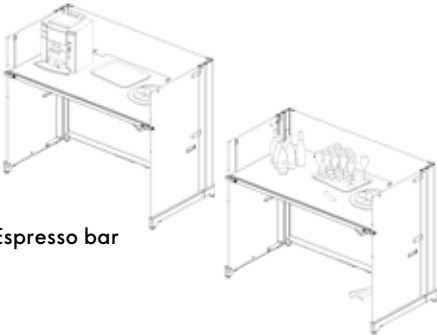
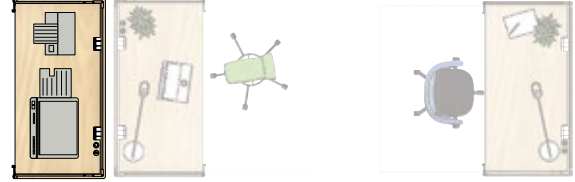
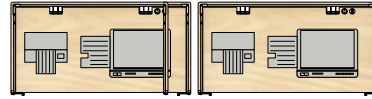

Espresso bar

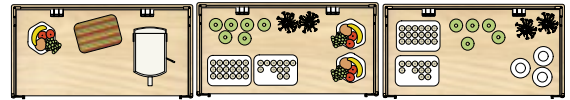

Lounge

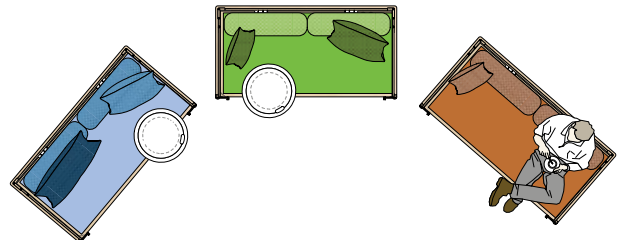

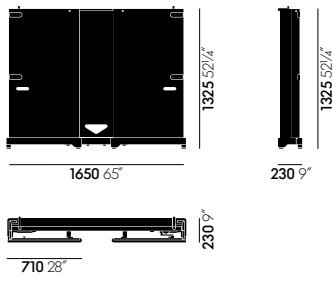

**HACK closed**

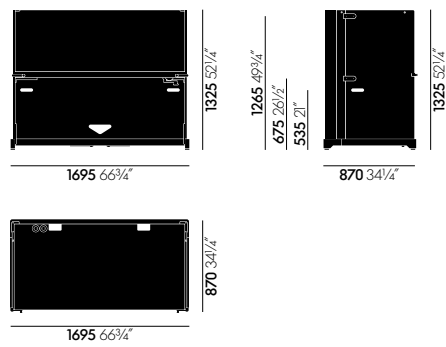

**HACK open**



**Cushion set**

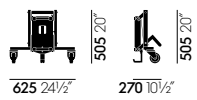

**Transport aid**





Laser

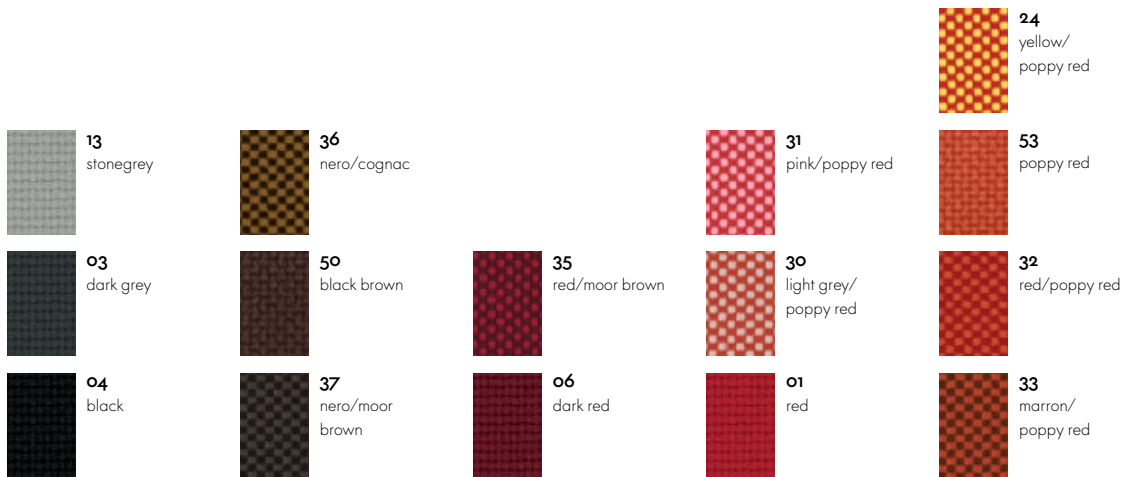

Laser



Aluminium profiles

Wooden parts

Frame







